

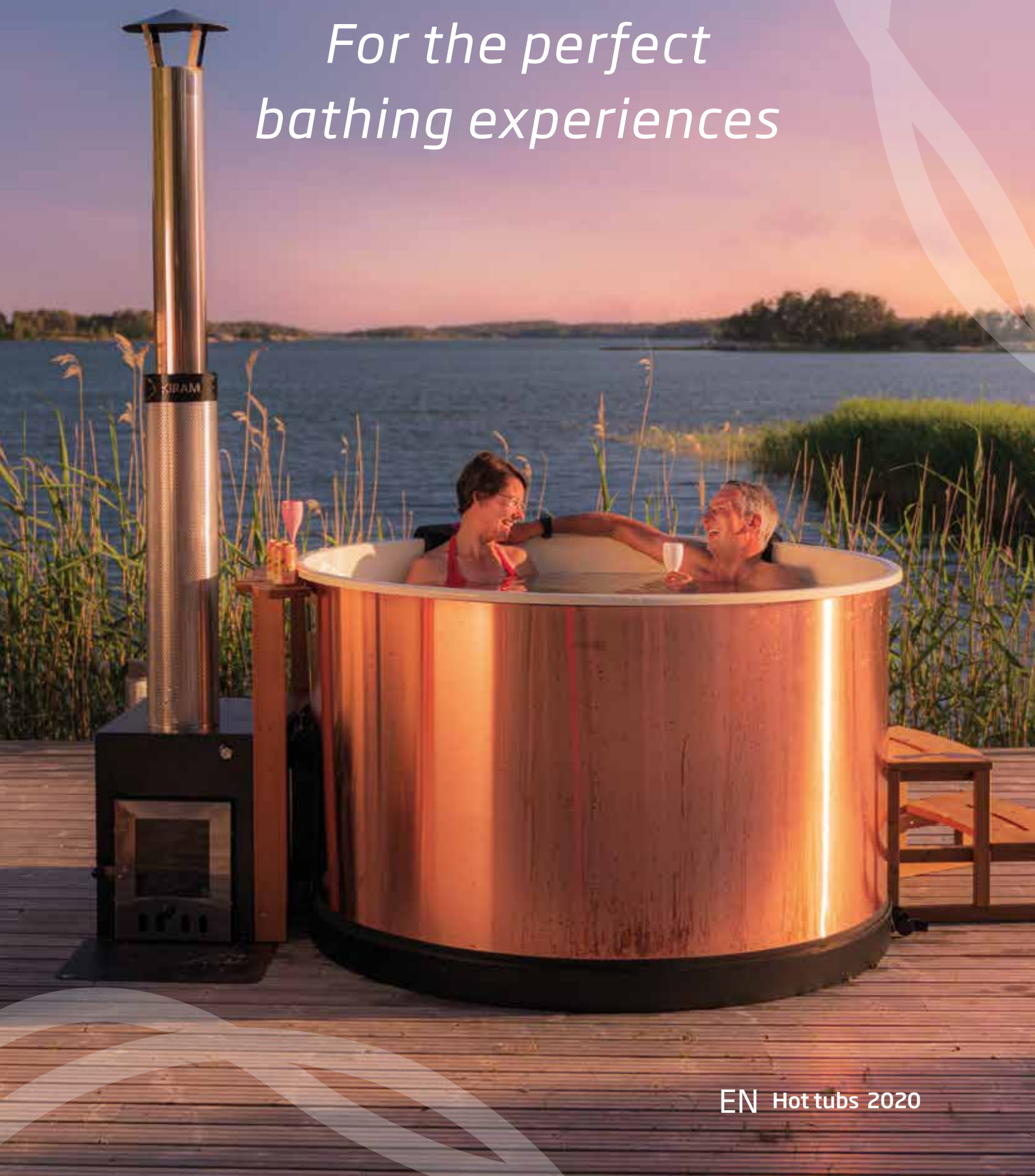

Warmer feelings.

*For the perfect
bathing experiences*





Kirami provides its customers with high-quality wood-heated tubs and a wide array of different kinds of supplies and accessories. 5,000 tubs made by Kirami are sold annually all over Europe, and their popularity is growing constantly. Kirami is the largest hot tub supplier in Europe.

The story of Kirami started in 2001. The first hot tubs were imported from Sweden, but the company's own production started soon after. The company moved into larger premises in 2006, and the product range expanded to cover hot tubs made out of ThermoWood. Kirami moved into its current premises of more than 3,000 square metres in early 2011. Hot tubs with a plastic inner tub and a comprehensive range of water treatment chemicals were launched the following year. The product range expanded yet again in 2015. The high-quality Outstanding product line focused on BBQ grills, outdoor fireplaces and outdoor decoration made out of fashionable, robust COR-TEN steel. New ground was broken again last year when Kirami launched the FinVision sauna with a close connection to nature.

Kirami's business concept is to offer high-quality products that are easy to use and that you are happy to show off and recommend to your friends and acquaintances, too. All of our tubs and pools are manufactured by hand from carefully selected materials, and they are assembled at our factory in Sastamala, Western Finland.



New products, even more enjoyable baths

When designing Kirami's product range for 2020, we thought about how we could make bathing even more enjoyable and developed a few interesting new products. Among other things, they include **Tiny** and **Woody Tiny**, new small tubs that fit even in yards that do not have enough room for a full-size hot tub. Our **Chill** tub also reaches new yards; shallower than usual, it can pass through even narrow gates when raised upright. We already hinted about our **Steady** and **Pearly** tubs in our last catalogue, and they are now a part of our standard range. We should also mention **Family L**, our only hot tub with a 2 m plastic inner tub that instantly became wildly popular. Another hit were the **LED lights** available for Kirami's translucent inner tubs that make bathing a perfectly magical experience. The convenient floating Tubbar drink holder has been updated and improved, and it is now called **Tubbar 2**. The **FinVision Sauna** breaks completely new ground. It is the perfect sauna, easy to install and equipped with a large panorama window that showcases the beauty of the surrounding nature..

Enjoy browsing our new product catalogue!

CONTENTS

4-5	Tuoteryhmät
6-7	What Kirami is
8-15	Original
16-23	Comfort
24-27	Premium
28	Colours and Materials
30	Heaters
32	Steps and drink holders
33	Covers and locks
34	Tubbar 2
35	Other equipment
36	Carefully thought out details
38	An enjoyable bath starts with clean water
40-41	Outstanding
42	Kirami FinVision Sauna
44	Kirami is also a safety pioneer

Original



Kirami Original is a bathing experience at its most genuine. The quality of the simple, traditional hot tubs is born out of their carefully selected materials and finishing. The Original product line has an option available for groups of bathers of every size. The new Breezy is an easy-care basic hot tub. As for the Woody tubs, they appeal to nature lovers who appreciate the atmosphere created by real wood. **Chill** is shallower than the other hot tubs, which makes it easier to transport even to small yards; the resting sitting position gives you a completely new way to relax in the tub. New models also include **Tiny** and **Woody Tiny**, which offer a pleasant setting for two people to bathe together. Kirami Original is purely Finnish.



Premium



The Premium series includes our finest products. Their design, usability and comfort of use are in a class of their own. The latest additions to the Premium product family are the luxurious Pearly, which is also available with a truly stunning outer surface in copper, and the **Grandy XL**, which is the largest tub in our product range as its name suggests. The Premium products maintain their appealing looks year after year, even in challenging conditions.





Comfort



The Kirami Comfort hot tubs are easy-care plastic tubs suitable for active bathers. **Steady**, the new addition to the Comfort series, is the perfect choice for people who value modern style and comfort. The wildly popular Family M has been joined by a larger L version that is big enough for large families. The Family hot tubs are designed to take the needs of families with children, elderly people and disabled people into account by ensuring that getting into and out of the tub is as easy and safe as possible.



Kirami's:

Easy to buy:

- wide range of products
- appearance and placement can be tested with a 3D application
- professional reseller network
- can be placed almost anywhere
- delivered already assembled; the customer only needs to attach the heater and the chimney
- clear, comprehensive instructions
- can be delivered anywhere
- plenty of product information on the website (blogs, FAQ, product cards).



Safe to use:

- all chimney packages include a heat shield
- thanks to the water jacket, the heater never becomes burning hot
- lockable covers
- protective grates for the discharge outlets on the bottom of the tubs
- LED lights installed safely at the factory
- sturdy and safe steps that fit all hot tubs
- models that take the needs of families with children, elderly people and disabled people into account in particular
- safety requirements in accordance with the standards have been taken into account.

Effortless to equip:

- suitable covers, steps and drink holders available for all models
- plenty of accessories, such as neck rests and LED lights.

Easy to care:

- easy to empty completely out of water
- simple to keep clean
- the heater is easy to clean
- an anode rod protects the heater from corrosion and ensures a long service life
- the EPS base is light and weatherproofed
- outer surface options that require no maintenance: EcoPlank, EcoStripe, Metal and Copper
- the cover protects the tub from rubbish and keeps the bathwater warm.

A responsible choice:

- made in Finland
- standardised
- responsible manufacturer
- the whole lifespan has been considered: long-lasting and recyclable.



Warmer feelings.

+



+



+

**Standard
EN 17125**



Original

*Quickly heated Chill for
perfect relaxation.*





NEW

Chill

M
 x 3-4

CHILL offers a new way of hottubbing. The lower bench ensures relaxing laying comfort. It makes CHILL perfect for lazy summer days and evenings. As a lower model CHILL is very comfortable also for children to play in it. CHILL is an excellent choice for those, who have tiny gardens. Because of its total height of 90 cm, it can be easily carried even through the apartment to the backyard. The smaller amount of water saves time and money.



External colours:



Coal Black

Internal colours:



Stone Grey

	M
WATER CAPACITY	1350 l
MINIMUM WATER CAPACITY	490 l
HEATER	MICU
DIAMETER	170 cm
DEPTH	73 cm
TOTAL HEIGHT	90 cm
BENCH	built in around 5 cm high
WEIGHT	96 kg
WATER OUTLET	2 1/2" female + coupling 38 mm
CHIMNEY	Ø 120mm, 1,5m + Hat
CHIMNEY HEAT SHIELD	1 m
FITTING COVER MODELS	Plastic cover / Insulated cover



Original

Breezy - always a good choice





Breezy



M
 x 4-6

The Original product range, Breezy is a hot tub with a plastic inner tub in a solid colour. Both of the inner colour options come with safe LED lighting (Legroom led coronas) as an accessory; its glow brings out the tub's own colour. This enduring tub model is suitable for all purposes, making it a good choice for any situation. A new surface material option is coated metal, also familiar from roofing; thanks to the material, the outer surface of the tub requires no maintenance. Its size makes Breezy M suitable for the average family, or why not a gettogether with a small group of friends!

External colours:

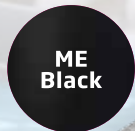

Internal colours:



	M
WATER CAPACITY	1450 l
MINIMUM WATER CAPACITY	650 l
HEATER	CULT
DIAMETER	170 cm
DEPTH	91 cm
TOTAL HEIGHT	110 cm
BENCH	built in around
WEIGHT	130 kg
WATER OUTLET	2 1/2" female + coupling 38 mm
CHIMNEY	Ø 120 mm, 1,5 m + Hat
CHIMNEY HEAT SHIELD	1 m
FITTING COVER MODELS	Plastic cover / Insulated cover



Original

*Small size,
great enjoyment
- Tiny and Woody Tiny*

**New for
2020**



Tiny

Part of our Original range, Tiny is a compact easy-care hot tub with a single-colour plastic interior. This petite hot tub features two shaped seats, making it ideal for one or two persons. Light in weight and compact in size, the hot tub is easy to install in both small yards and on terraces. Thanks to its small water volume, Tiny is quick to heat up, allowing you to enjoy a spot of luxury even on busy weekday evenings. The interior colour option is available with safe LED lighting as an accessory, which is installed at the factory. The glow of the LED lighting creates a magical atmosphere to bathing in the darkening night.



External colours:



Internal colours:



	S
WATER CAPACITY	690 l
MINIMUM WATER CAPACITY	475 l
HEATER	MICU
DIAMETER	"length" 202 cm inner 193 cm
DEPTH	73 cm
TOTAL HEIGHT	74 cm
OUTER WIDTH	85 cm
INNER WIDTH	57 cm-69 cm
BENCH	shaped seat at both ends of the tub
WEIGHT	128 kg
WATER OUTLET	1" female + coupling 32 mm
CHIMNEY	Ø 120 mm, 1,5 m + Hat
CHIMNEY HEAT SHIELD	1 m
FITTING COVER MODELS	Insulated cover

Woody Tiny

S
x 1-2

The Original Woody Tiny hot tub offers the authentic atmosphere of wood in a compact size. Woody Tiny is our smallest solid wood hot tub, ideal for both small yards and terraces. The compact size of Woody Tiny makes it perfect for couples and conditions where water consumption must be kept to a minimum. Thanks to its small water volume, the hot tub is also quick to heat up, allowing you to take a relaxing dip even on the busiest of evenings. The Woody Tiny hot tub offers everything you need for a great, wood-heated hot tub experience.



External colours:



Internal colours:



	S
WATER CAPACITY	1000 l
MINIMUM WATER CAPACITY	640 l
HEATER	MICU
DIAMETER	"length" 156 cm inner 148 cm
DEPTH	85 cm
TOTAL HEIGHT	98 cm
OUTER WIDTH	90 cm
INNER WIDTH	82 cm
BENCH	2-boards in each end of the hot tub
WEIGHT	85 kg
WATER OUTLET	50 mm
CHIMNEY	Ø 120 mm, 1,5 m + Hat
CHIMNEY HEAT SHIELD	1 m
FITTING COVER MODELS	Insulated cover



Original

*For nature lovers:
the Woody, rich in
atmosphere*

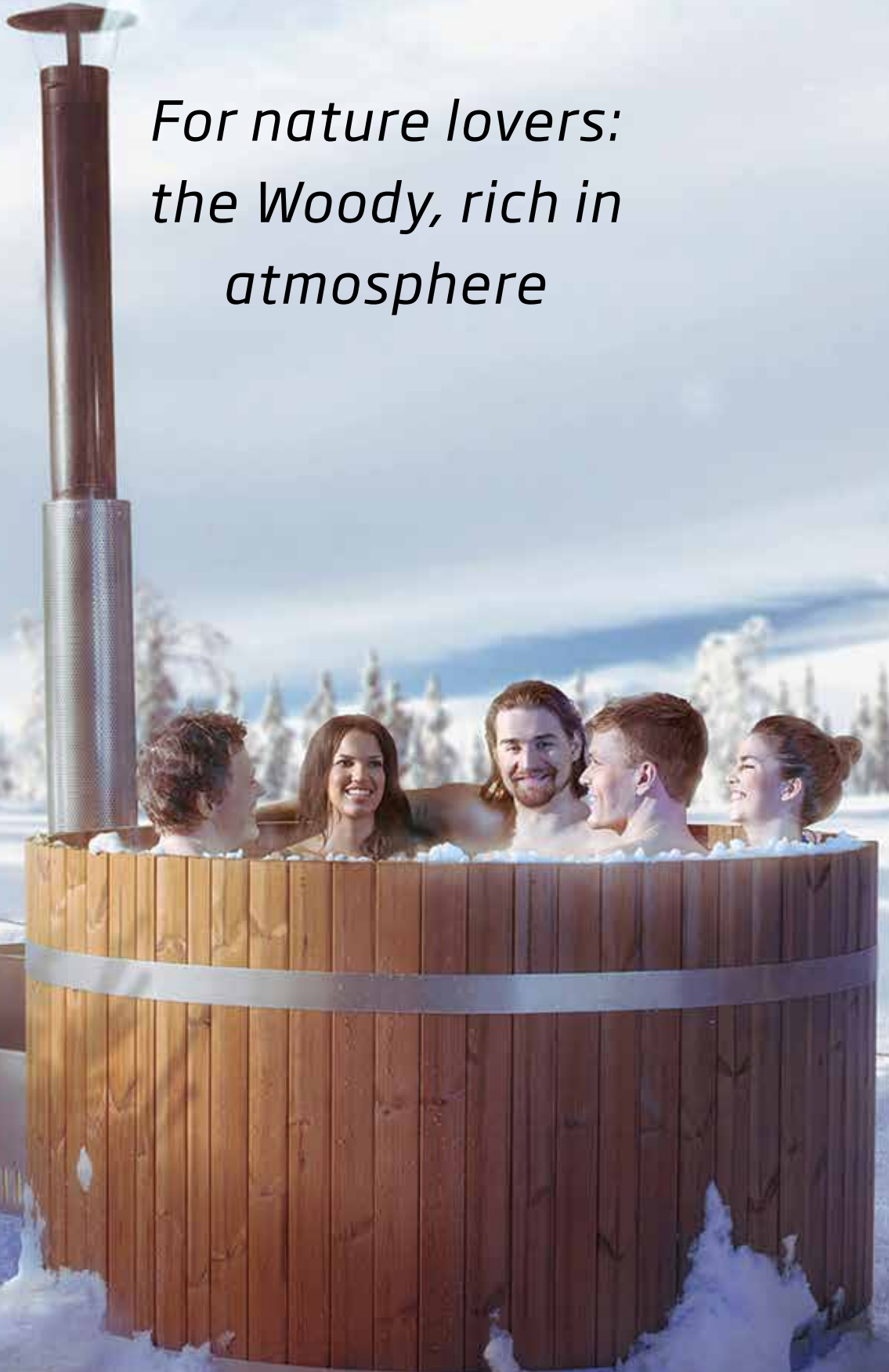

Woody



M

♀ x 4-6

L

♀ x 6-8

XL

♀ x 8-12

Original Woody hot tubs are made of Thermowood, which creates the original wooden feel and authentic atmosphere. These models offer a great choice with different heaters, from the traditional SUB underwater heater to the extremely powerful TUBE heater. The wide range of the collection makes it easy to find a suitable model to fit your patio.



External colours:

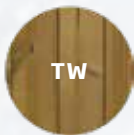

TW

Internal colours:

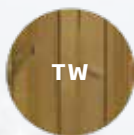

TW

Woody Premium



M

♀ x 4-6

L

♀ x 6-8

The Woody Premium hot tubs are made of the luxuriously stylish Red Cedar that creates a genuine, natural mood for spa moments. The wood is light, with top quality rot resistance. The Woody Premium hot tubs are finished by hand, and the extremely efficient CUBE and TUBE heaters make everything complete.



External colours:



RC

Internal colours:



RC

	M	L	XL
WATER CAPACITY	1860 l	2600 l	3180 l
MINIMUM WATER CAPACITY	1460 l	2060 l	2800 l
HEATER	SUB/CUBE/TUBE	SUB/CUBE/TUBE	TUBE
DIAMETER	170 cm	200 cm	220 cm
DEPTH	95 cm	95 cm	95 cm
TOTAL HEIGHT	108 cm	108 cm	108 cm
BENCH	two planks around	two planks around	two planks around
WEIGHT	190 kg	210 kg	230 kg
WATER OUTLET	50 mm	50 mm	50 mm
CHIMNEY	Ø 150 mm, 2 m + Hat	Ø 150 mm, 2 m + Hat	Ø 150 mm, 2 m + Hat
CHIMNEY HEAT SHIELD	1 m	1 m	1 m
FITTING COVER MODELS	Plastic cover / Insulated cover	Insulated cover	Insulated cover

	M	L
WATER CAPACITY	1860 l	2600 l
MINIMUM WATER CAPACITY	1460 l	2060 l
HEATER	CUBE/TUBE	CUBE/TUBE
DIAMETER	170 cm	200 cm
DEPTH	95 cm	95 cm
TOTAL HEIGHT	108 cm	108 cm
BENCH	two planks around	two planks around
WEIGHT	190 kg	210 kg
WATER OUTLET	50 mm	50 mm
CHIMNEY	Ø 150 mm, 2 m + Hat	Ø 150 mm, 2 m + Hat
CHIMNEY HEAT SHIELD	1 m	1 m
FITTING COVER MODELS	Plastic cover / Insulated cover	Insulated cover



Comfort

*The spacious, safe Family M
is designed for the whole family*

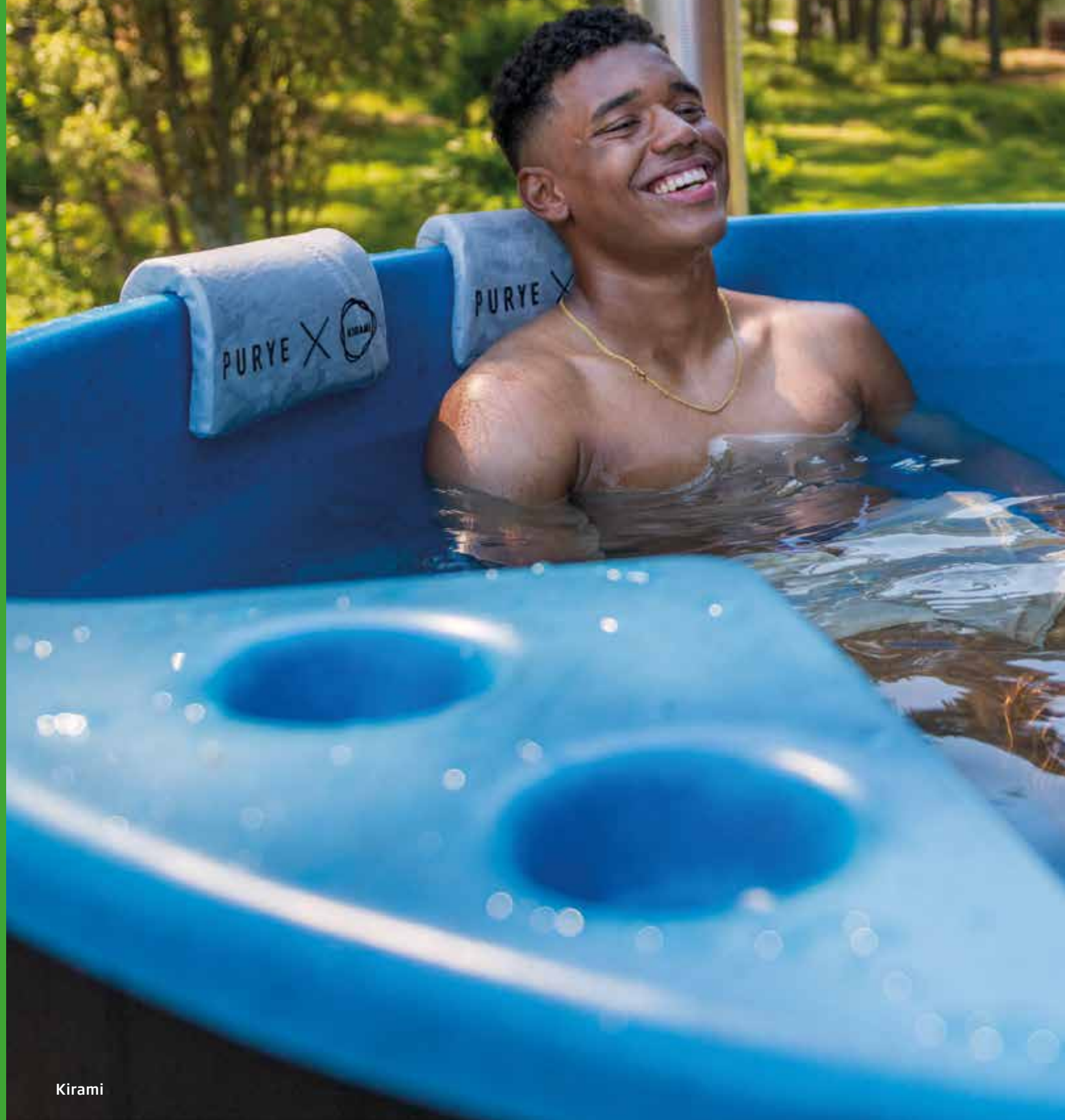

**THE
POPULAR
FAVOURITE**

Family M

M
x 4-6

The Family hot tub has been developed to take the needs of children, elderly people and disabled people into account. In addition to practicality, its development has focused increasingly on safety. The inner step makes it easier to climb into the tub. It also makes the height of the tub more comfortable and relaxed for children and shorter people.

External colours:

Coal Black

TW

EP Night Black

EP Mocca

RC

Internal colours:

Stone Grey

Soft Beige

Ocean Blue

LED

LED



	M
WATER CAPACITY	1370 l
MINIMUM WATER CAPACITY	590 l
HEATER	CULT-Silver/ MACU / Tubtainer 2
DIAMETER	170 cm
DEPTH	91 cm
TOTAL HEIGHT	110 cm
BENCH	built in around
WEIGHT	175 kg
WATER OUTLET	2 1/2" female + coupling 38 mm
CHIMNEY	Ø 120 mm, 1,5 m + Hat
CHIMNEY HEAT SHIELD	1 m
FITTING COVER MODELS	Plastic cover / Insulated cover



Comfort

*Family L - bathing experiences
for families of all sizes*



Family L

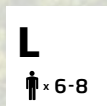

The Comfort series now includes the new Family L hot tub, which has enough space for even a group of bathers with the widest shoulders. The features of the tub are just as userfriendly as those of the M-size Family. The tub has a velvety smooth dotted blue, beige or grey interior surface, and there are various colour and material options for the exterior surface. The TUBE and CUBE heaters ensure fast and efficient heating.

External colours:



Coal Black



TW



RC



EP Mocca



EP Night Black

Internal colours:



Stone Grey



Soft Beige



Ocean Blue



	L
WATER CAPACITY	1930 l
MINIMUM WATER CAPACITY	722/1050 l
HEATER	CUBE / TUBE
DIAMETER	200 cm
DEPTH	91 cm
TOTAL HEIGHT	110 cm
BENCH	built in around
WEIGHT	180 kg
WATER OUTLET	2 1/2" female + coupling 38 mm
CHIMNEY	Ø 150 mm, 2 m + Hat
CHIMNEY HEAT SHIELD	1 m
FITTING COVER MODELS	Insulated cover



Comfort

Steady - modern comfort



We cooperate with VaLePa, the 2019 Finnish volleyball champions.

Kirami



NEW

Steady

M
 x 4-6

The hot tubs in the Comfort series offer comfort and modern style for people who appreciate easy-care products. The new Steady hot tub in the Comfort series is designed to ensure that stepping into and out of the tub is easy. In addition to the traditional wood as surface material, Steady can be panelled with the renewed EcoPlank outer shell that requires no maintenance. The smooth plastic surfaces of the tub in light colours make it possible to install Kirami's safe LED lights to all Steady tubs.



External colours:

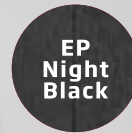

Internal colours:



	M
WATER CAPACITY	1420 l
MINIMUM WATER CAPACITY	600 l
HEATER	MACU / CUBE
DIAMETER	170 cm
DEPTH	90 cm
TOTAL HEIGHT	107 cm
BENCH	built in around
WEIGHT	160 kg
WATER OUTLET	2 1/2" female + coupling 38 mm
CHIMNEY	Ø 150 mm, 2 m + Hat
CHIMNEY HEAT SHIELD	1 m
FITTING COVER MODELS	Plastic cover / Insulated cover



Comfort

*Cozy M - modern, comfortable
and always elegant*



Cozy

M

 x 4-6

Cozy M is a modern and easy-to-care-for hot tub and its velvety smooth dotted plastic surface of the inner tub exudes luxury. Thanks to its thick bottom insulation, the hot tub works well even in arctic conditions. Cozy M suits well for the average family or a small group. The hot tub is heated with a shapely external grey Macu heater made out of high-quality marine-grade aluminium. The heat-treated pine used in the outer shell is a Finnish alternative for dark-coloured imported wood. ThermoWood is a high-quality, long-lasting material with a warm brown colour. The soft, vibrant grey of the interior blends in beautifully with the environment.



	M
WATER CAPACITY	1450 l
MINIMUM WATER CAPACITY	650 l
HEATER	MACU / CUBE
DIAMETER	170 cm
DEPTH	91 cm
TOTAL HEIGHT	110 cm
BENCH	built in around
WEIGHT	160 kg
WATER OUTLET	2 1/2" female + coupling 38 mm
CHIMNEY	Ø 150 mm, 2 m + Hat
CHIMNEY HEAT SHIELD	1 m
FITTING COVER MODELS	Plastic cover / Insulated cover



Premium

*Pearly - when you really
want to pamper yourself*

NEW

Pearly



M
x 4-6

The strengths of the Premium Pearly tub include the userfriendly design familiar from the Family series. Premium Pearly is the choice of bathers who value easy-care products of high quality. The tub's glossy, champagne-coloured inner tub made out of ABS plastic represents the highest class of hot tubs. The surface materials also include elegant copper (ME) that follows the shapes of the tub; in addition to being stylish, it also means that the outer surface of the tub requires no maintenance and ages gracefully.

External colours:



RC



ME
Copper



ES
Night-
Black



ES
Mocca

Internal colours:



Champagne
LED



	M
WATER CAPACITY	1420 l
MINIMUM WATER CAPACITY	600 l
HEATER	CUBE
DIAMETER	170 cm
DEPTH	91 cm
TOTAL HEIGHT	107 cm
BENCH	built in around
WEIGHT	160 kg
WATER OUTLET	2 1/2" female + coupling 38 mm
CHIMNEY	Ø 150 mm, 2 m + Hat
CHIMNEY HEAT SHIELD	1 m
FITTING COVER MODELS	Insulated cover



Premium

*Grandy XL - for even
greater bathing experiences*





Grandy XL



XL
 8-12

The Grandy minipool is a hot tub big enough to fit a larger party of bathers at the same time. The tub also acts as a children's swimming pool. Grandy is considerably larger than traditional hot tubs, a bit deeper, and cubical in shape, and it has built-in steps on one side. There are several options for heating the tub water: the TUBE heater, TUBE combined with a Tubtainer 2 maintenance heater or a Rexener oil heater. LED lights on the edge of the tub are available as an accessory.

External colours:



TW



TW-BG

Internal colours:



Ocean Blue

LED



	XL
WATER CAPACITY	3600 l
MINIMUM WATER CAPACITY	2800 l
HEATER	Tube / Tube + Tubtainer 2 / Rexener
DIAMETER	247 cm
DEPTH	91 cm
TOTAL HEIGHT	121 cm
BENCH	built in around
WEIGHT	290 kg
FITTING COVER MODELS	Insulated cover

Colours & Materials

The benefits of plastic tubs include great hygiene and flexibility. Dirt and impurities come off easily from the smooth inner surface, which does not peel even after years of use. The inner surface requires no maintenance, which means that the tub stays neat and clean year after year. Kirami's plastic tubs have been made out of either LDPE (low-density polyethylene) or HDPE (high-density polyethylene). LDPE and HDPE plastics are used in the food industry, and they are recyclable and UV protected. Both plastics come in several different colours. The inner surface of a tub made out of HDPE plastic is velvety smooth.

Inside colours and materials:

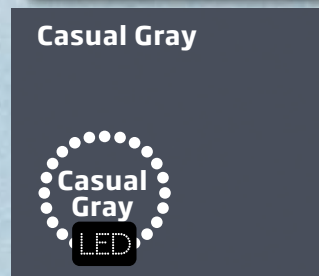
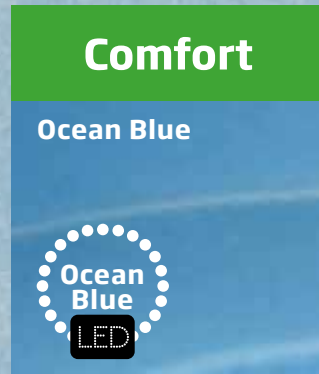

Polar Blue

The fresh, translucent blue calms down and relaxes the mind after a busy day.

Light Gray

The slightly translucent, velvety smooth dotted light gray is both trendy and timeless. Suitable for all environments.

Ocean Blue

Velvety smooth, ocean blue dotted colour with a translucent surface.

Soft Beige

The translucent dotted beige is neutral, stylish and velvety smooth.

Casual Gray

The translucent grey is always stylish and aesthetic. Harmonious and suitable for many different kinds of environments.

Caramel Beige

The caramel-toned beige is a warm, translucent colour that highlights the peace of nature.

Stone Gray

The soft, vivid grey blends in beautifully with the environment; it is always timeless elegant.

Champagne

A clear, magnificently glossy champagne colour for elegant and memorable bathing experiences.

The colour samples may differ from the actual product colours.

LED lights available for the Stone Gray inner tub of the Tiny tub.



LED lights are available as an accessory for colours marked with this symbol.

Outside colours and materials:

Original

Stained Spruce (ST)

Dark Walnut

Comfort

EcoPlank (EP)

Night Black

Premium

EcoStripe (ES)

Night Black

Stained Spruce (ST)

Coal Black

EcoPlank (EP)

Mocca

EcoStripe (ES)

Mocca

Thermowood (TW)

Thermo wood

Stained Spruce (ST)

Coal Black

Red Cedar (RC)

Red Cedar

Metal (ME)

Black

Thermowood (TW)

Thermo wood

Metal (ME)

Copper

Red Cedar (RC)

Red Cedar

EcoPlank (EP)

A durable panel made out of recycled plastic with a smooth surface that requires no maintenance.

EcoStripes (ES)

A durable panel made out of recycled plastic with a grooved surface that requires no maintenance.

Stained Spruce (ST)

Natural stained spruce panel. The beautiful brown tint will stay goodlooking for a long time. We recommend re-staining every couple of years.

Thermowood (TW)

Original and natural heat treated pine panels have beautiful warm brown shade.

Red Cedar (RC)

Multi-hued, nearly branchless wood is very beautiful and becomes darker over time, into a more even grey hue. Top quality rot resistance.

Metal, Copper (ME)

The material requires no effort or maintenance and develops an elegant green patina over time.

Metal, Black (ME)

This surface material is here to stay. Because it is stainless and weather-proof, it requires no maintenance.

Heaters

All Kirami hot tub heaters are made in high-class AlMg3 marine aluminium, which is an excellent heat conductor. Every heater is pressure-tested for leakages before it leaves our factory.



	CULT	MACU	CUBE	TUBE
POWER (NET)	22 kW	29 kW	35 kW	42 kW
HEATING TIME IN M SIZED TUBS *	2,5-3 h	2-2,5 h	1,5-2 h	1,5 h
HEATING TIME IN L SIZED TUBS*	x	x	2-3 h	2 h
FUEL	puu, hiili	puu, hiili	puu, hiili	puu, hiili
CHIMNEY CONNECTION	Ø 120 mm	Ø 150 mm	Ø 150 mm	Ø 150 mm
WATER CAPACITY	54 l	79 l	80 l	76 l
OUTSIDE MEASUREMENTS W X H X D	350 x 620 x 740 mm	570 x 590 x 600 mm	570 x 590 x 600 mm	640 x 700 x 695 mm
FURNACE'S MEASUREMENTS W X H X D	280 x 190 x 550 mm	280 x 190 x 550 mm	280 x 290 x 550 mm	350 x 360 x 550 mm
STANDARD IN MODELS	Breezy, Family	Steady	Breezy, Pearly	Family L
OPERATING PRINCIPLE	free circulation	free circulation	free circulation	free circulation
CONNECTION TO HOT TUB	Ø 75 mm smooth pipe	Ø 75 mm smooth pipe	Ø 75 mm smooth pipe	Ø 75 mm smooth pipe
WEIGHT	36 kg	39 kg	42 kg	50 kg

*The heating durations presented here are estimates based on practical tests. The actual duration depends on the circumstances, the firewood's quality, size and humidity, the intensity of the maintained fire and the rate with which new firewood is added.

	MICU
POWER (NET)	19 kW
HEATING TIME CHILL:	3 h
HEATING TIME TINY/TINY WOODY	2,5 h
FUEL	puu, hiili
CHIMNEY CONNECTION	Ø 120 mm
WATER CAPACITY	22 l
OUTSIDE MEASUREMENTS W X H X D	340 x 400 x 600 mm
FURNACE'S MEASUREMENTS W X H X D	278 x 337 x 524 mm
STANDARD IN MODELS	Tiny, Tiny Woody and Chill
OPERATING PRINCIPLE	free circulation
CONNECTION TO HOT TUB	Ø 75 mm smooth pipe
WEIGHT	19 kg

MICU heater

An affordable, compact heater option for smaller tubs, such as the **Chill** and **Tiny** hot tubs.



NEW

Heating a hot tub

The external heaters, manufactured by Kirami, are high-quality and easy to use. Use spills to light dry firewood that has been chopped into small pieces. Keep the temperature hot to produce less visible smoke. The heating is at its most efficient when the tub is covered and the fire in the heater is as hot as possible. Ensure that there are no flammable materials in front of or under the fire chamber. The heater will not heat up above the water temperature as the stove is surrounded by a water jacket. Make sure that there is enough water in the tub.

Hearth plate

The fireproof hearth plate designed for Kirami's heaters protects the area in front of the heater from sparks, improving the fire safety.

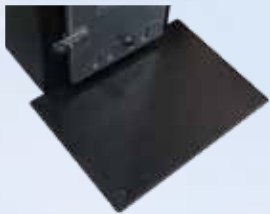

Anode- Rod

Kirami's magnesium anode rod protects your heater from corrosion. The rod is screwed to the place reserved for it in the heater, and it is replaced approximately once per year.

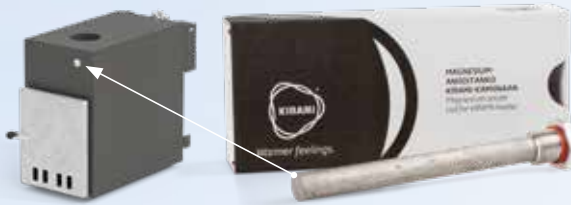

Chimney parts

Extension pieces and spare parts are also available for Kirami's heater chimneys.



NEW

Heater glass doors

Available as an accessory, a glass heater door not only adds to the atmosphere of your hot tub by allowing you to enjoy the cozy glow of the fire, but also makes it easier to monitor wood consumption. The glass door is compatible with most Kirami hot tub heaters: **MICU, MACU, CULT** and new **CUBE** heaters (those manufactured after 2017).



Alternative heating methods

Tubtainer 2 is an easy-to-use electric hot tub heater and filter unit. The system consists of an electric heater, a circulation pump, a filter and an operating panel. The maintenance heat only consumes a few dozen cents' worth of electricity per day, depending on the temperature outdoors. The water in the hot tub can remain ready for swimming up to several weeks with the integrated, automatic filter, when the necessary cleaning agents are also used in the tub. The Tubtainer 2 -heater can be used in addition to a traditional woodheated heater, or the tub can be heated by using only electricity. An electric heater is a good option when heating with wood is not possible.

Tubtainer 2 -heater can be used in addition to a traditional woodheated heater, or the tub can be heated by using only electricity.

TUBTAINER 2	
HEATING CAPACITY	2 kW
ENERGY SOURCE	Electricity
DIMENSIONS (W X D X H)	410 x 605 x 645 mm
WEIGHT	33 kg
PURPOSE OF USE	Filtering bathwater, heating the water and maintaining the water temperature

Rexener PR-200 is very efficient, easy-to-use and economical heater for heating the water in a hot tub or swimming pool. The recommended fuel for the Rexener PR-200 water heater is biodiesel, but it also runs smoothly with diesel or fuel oil. NOTE! In order to work, the heater requires a circulation pump that is sold separately.

REXENER PR-200	
HEATING CAPACITY	20 kW
FUEL CONSUMPTION	2,0 l/h
ENERGY SOURCE	Biodiesel, diesel or fuel oil
DIMENSIONS (W X D X H)	320 x 580 x 839 mm
WEIGHT	38 kg
PURPOSE OF USE	Heating and maintaining heat





Steps and drink holders



MADE IN FINLAND

Thanks to their high-quality materials, the steps and drink holders we design and manufacture will last for years even in the harshest weather conditions. The sturdy steps guarantee that you can step safely into and out of the hot tub, and the drink holders increase the comfort and enjoyment of bathing. Some models also come in different colours and made out of different materials. You can find more detailed information at our website: www.kirami.fi/en

Step-A-round



Stepin



Delux



Family staircase



Drink Arc with legs



Drink Arc



Drink Arc high drink holder



Covers and locks

MADE IN  FINLAND

We have covers for all of our hot tubs. Most hot tubs have both a plastic cover and an insulated cover available. Durable and high-quality insulated covers for hot tubs with dedicated versions for both external and internal heaters. A cover is especially useful accessory: with it you can speed up heating of your hot tub, keep the water hot for a longer time and optimize heating performance on the following day. The cover also protects your hot tub from debris and with a cover your hot tub remains clean when empty, and as well it protects inner parts of hot tub from UV-radiation. The cover improves safety especially for families with children and pets.



ABS plastic round cover

Suitable for tubs with a diameter of 170cm with an outside heater. The plastic cover becomes a safety cover when you add a safety lock to it, available as an accessory. A lockable hot tub cover is an important safety feature that prevents small children from getting into the tub unsupervised, for example.

Cover safety locks

A sturdy safety lock with a key is available for the plastic hot tub covers as an accessory.

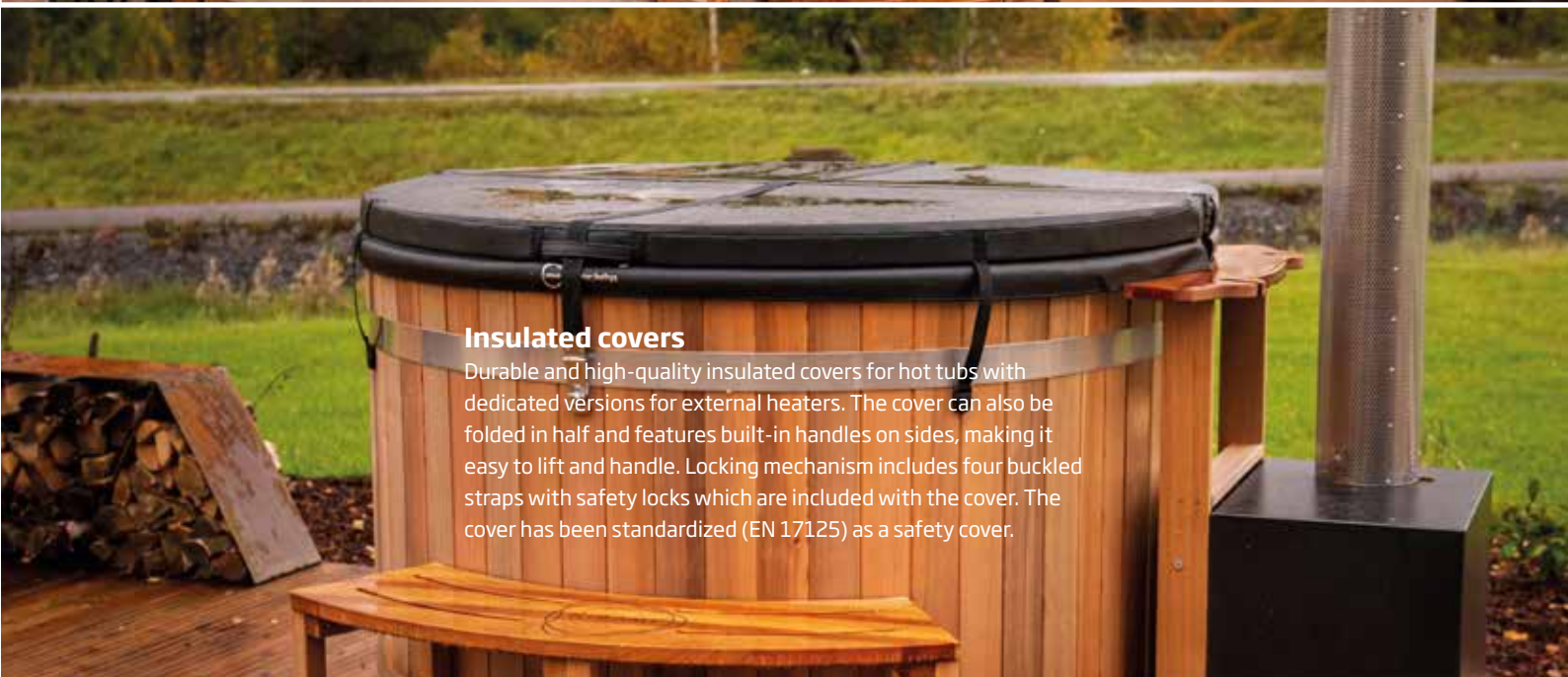

Insulated covers

Durable and high-quality insulated covers for hot tubs with dedicated versions for external heaters. The cover can also be folded in half and features built-in handles on sides, making it easy to lift and handle. Locking mechanism includes four buckled straps with safety locks which are included with the cover. The cover has been standardized (EN 17125) as a safety cover.

Kirami Tubbar 2

Kirami's floating TUBBAR 2 drink holder is not only convenient and weather-resistant, but pleasing to the eye. Kirami's floating drink holders are high-quality and user-friendly. They insulate the heat coming off the bath water and keep your drinks fresh and cold. The products also provide a fun element as they float between the bathers, and no one has to retrieve refreshments as they are always within everyone's reach. These drink holders also feature marked places for drinks to help bathers find their own glasses despite the holder moving around. The drink holder is designed and manufactured in Finland.



Other accessories

Kirami has plenty of different kinds of accessories and equipment that help you make your spa moments even more fun and enjoyable. Among other things, our range of products includes several new drink holders of different materials as well as bathing hats that help you relax further. Bathing hats keep you warm when it is cold, and they protect you from mosquito bites during the summer.

You can find more accessories at: www.kirami.fi/en



Thermometers



Beanie



Tub hats

Carefully thought out details



LED lights

The LED lights that have been installed to the tub already at the factory create a magical atmosphere to bathing in the darkening night.

Accessories



Accessories

Extension pipe kit



The kit contains all the parts you need to install an outlet valve between the heater and the tub. The product does not include a Kirami outlet valve; it replaces the existing outlet.

EPS insulation

The EPS insulation under the bench and the bottom reflects the heat back from the water and increases seating comfort.



Outlet hoses

Outlet hoses/feed-through kits for attaching external filters or heaters to Kirami hot tubs. You can purchase additional hoses and other equipment and supplies, such as chemicals, from us as needed.



Accessories

The feed-through kit is used to attach a filter to Kirami hot tubs in addition to a heater (38 mm).



Accessories

Side insulation

Hot tubs with plastic interiors can be equipped with additional insulation between the outer panels and plastic interior. The additional insulation consists of a 5 mm layer of insulating foam that is installed at our factory if the additional insulation is ordered with the hot tub.



Accessories



Middle outlet kit

A middle outlet kit for Kirami's external heaters that makes it possible to connect the heater at a distance from the hot tub.



Adjustment grids

Heater door adjustment grid for adjusting the air flow. The grid is standard equipment for the CUBE and TUBE heaters, and it can be purchased separately for the MICU, CULT and MACU heaters.

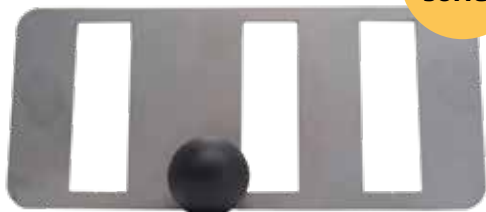

Accessories



Anode-Rod

Kirami's magnesium anode rod protects your heater from corrosion. The rod is screwed to the place reserved for it in the heater, and it is replaced approximately once per year.

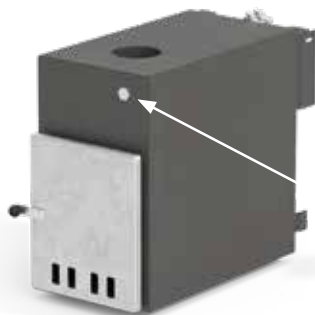

Chimney parts

Extension pieces and spare parts are also available for Kirami's heater chimneys.



Accessories



Hearth plate

The fireproof hearth plate designed for Kirami's heaters protects the area in front of the heater from sparks, improving the fire safety.



3D hot tub selector

Build the hot tub you want in the application and see how it fits in your own yard.

Water Treatment

How to keep your bathwater clean

You do not need to change the bathwater in the hot tub after every use, but if you reuse the same water, special attention must be paid to water hygiene.

Keeping water clean consists of two aspects:

- Maintaining the physical cleanliness of water with a filter.
- Eliminating bacteria and microbes with water treatment agents.

Filtering

The filter is intended to clean the water from dust, leaves, the dirt caused by bathing, and other impurities. This is done by circulating the water in the tub through a filter. There are different types of filters, such as light filters suitable for smaller pools that use a filter cartridge, as well as more efficient filters that use either filter sand or filter fibre.

Chemical cleaning

The hot tub water can be cleaned chemically either with chlorine or active oxygen. The correct water pH value is maintained with pH- and pH+ granules. In addition, there are chemicals available for preventing algae growth and clarifying water.

Other cleaning

It is important to keep the hot tub clean even when it is not in use. Warm water and sunshine easily cause algae growth in the bottom and walls of the tub. The algicide prevents algae bloom, and its use is recommended especially on hot summer days. Small dirt particles may bypass the filter system, making the water in the tub look discoloured or cloudy. The small impurities in the water can be precipitated with a clarifying agent, which makes it easier to filter them out of the tub.



**TUBTAINER 2
HEATER-FILTER UNIT.**
Easy to use electrical hot tub upkeep heater and filter unit. Hot tub's water will be usable for weeks with Tubtainer 2 and appropriate disinfection products.



Biowash, concentrate 5 litres

Biodegradable washing agent for cleaning and degreasing outdoor hot tubs and saunas.



Biowash, spray 0,5 litres

Pre-diluted, biodegradable washing agent for cleaning and degreasing outdoor hot tubs and saunas.



Sootwash, spray 0,5 litres

For removing soot and stubborn dirt from outdoor hot tub stoves, fireplaces and fireboxes.



Warmer feelings.

BioCool 

Coming soon



Biocool provides gentle, simple and effective products for clean water and healthy skin, that are kind to people and the environment. At Biocool we are passionate about making a contribution to society's efforts to reduce the use of chlorine and antibiotics.

Biocool Disinfect my pool

Biocool Disinfect my pool provides simple and effective disinfection of pool water and is biodegradable. No complementary products are required, although in certain cases it may be necessary to also use the flocculating agent Biocool Clear my pool water to ensure that small particles in the pool water can more easily be captured by the pool's filter. The product works at various pH values without losing effectiveness, which eliminates the need to perform a measurement of the pool water's pH value. With the help of the dosing module, dosing is made simple and occurs directly from the bottle, which makes this product significantly easier to use and handle than conventional methods. Biocool Disinfect my pool replaces chlorine, shock chlorination and algaecide and eliminates the need for pH measurement and adjustment.

Biocool Clear my pool water

Particles that are too small to be collected by the pool filter cause "milky" or cloudy water. Biocool Clear my pool water is a flocculating agent that effectively causes the particles to aggregate so that they can be captured by the filter. The filter is a central component of the pool's maintenance. We therefore recommend regular cleaning of the filter cartridge with Biocool Clean my pool filter.

Biocool Clean my pool filter

All particles in the pool water are collected in the system's filter cartridge. By ensuring regular cleaning of the filter cartridge, you also ensure the quality of the water in your pool. Biocool Clean my pool filter cleans the filter cartridge through a simple soaking process and requires minimal effort on the part of the user. The result is pool water that is free from dirt and harmful microorganisms such as bacteria, parasites or fungi. The product is biodegradable and carries the Swedish Asthma and Allergy Association's mark.



Disinfect my pool

Chlorine free disinfection for swimming pools, spas and hot tubs.



Clear my pool water

Chlorine free disinfection for swimming pools, spas and hot tubs. Recommended to use with BioCool products.



Clean my pool filter

Swimming pool filters cleaning.

All of Biocool's pool products are free from chlorine compounds that release active chlorine, and consequently the products do not generate any chloramines, which are harmful to people's health.

Outstanding

by KIRAMI

When guys get together. When form meets plain steel.
When the passionate barbecuer gets together with
the live flames. When the splashes of the soul meet
the warmth of the tub. "Look, your evening is ready."

MADE IN
FINLAND

IRON MONSTER



The Iron Monster is a frying plate made out of sturdy rolled steel, and it can either stand on its own feet or be placed on the Roasty Boss BBQ grill. On it, you can fry juicy steaks for the whole party at the same time! This extremely versatile cooking implement acts like an old-style cooking range.

The grill in the middle of the Iron Monster can be detached easily, which allows you to poke the fire conveniently through the hole. In addition to cooking, the Iron Monster can be used as a fireplace to create the perfect mood.



ROASTY BOSS



Roasty Boss is a heavy-duty BBQ grill, guaranteed to fill the needs of even the most demanding of cooks. A wide range of accessories from cooking and frying plates to grates. Roasty Boss is the summer cook's right hand, cooking steaks simultaneously for even a larger company while a pot of potatoes boils on the side. The frame is made of weathering Corten steel, and the rest is stainless steel. The Roasty Boss is the dream for BBQ chefs who are passionate about cooking. The equipment is sturdy and durable in use, and there is plenty of space to make several dishes at the same time.



Kirami

Iron Monster



Roasty Boss



Freedom



FREEDOM

Freedom is a modern outdoor fireplace, which offers the flicker of flames and pleasant warmth for anything from garden parties to hot tub parties. The crowning glory of the garden is easy to assemble and move around the decking or patio for the pleasure of people enjoying the hot tub. The body of the fireplace Freedom is made of weathering corten steel, which gains a rustic rust surface over time. The grid is made of stainless steel.

TRIHOLDY

Triholdy is a new, highly adaptable, outdoor decor sensation. The triangular elements can be combined to build an individual storage unit, partitions and firewood holders for the patio. Build a privacy screen or windbreak for the hot tub to match the style of your garden. The Triholdy can be transformed into a green wall using different arrangements of potted plants. Or the triangles can be laid flat and used as a planter.



LEATHER PATRON

This is no beer barrel cover - this is a truly stylish and manly apron, made out of thick antiqued leather of high quality, of course. A leather apron distinguishes the uncrowned king of the grill, and it makes an excellent gift.



KINDLING CRACKER

A safe and easy-to-use way to split firewood into kindling. Kindling Cracker is durable, because it is made out of one single piece of cast iron, and brushing is normally the only maintenance it needs.



TIP:
Get the best results in all grilling with Outstanding charcoal or birch firewood!

More information: outstanding360.fi/en



Kirami FinVision Sauna

The Kirami FinVision Sauna represents high-quality carpentry and continues the Finnish sauna tradition in a modern way. The sauna interior exudes a cosy atmosphere that relaxes all bathers. The glass wall brings the nature up close. The sauna is already surface-treated; it is made out of plain sawn spruce and spruce plywood. The sauna is a finished module that is installed on site.



	FINVISION
LENGTH	2300 mm
WIDTH	2300 mm
HEIGHT	Transport height 2580 mm, finished height 2625 mm
VOLUME	Interior: 9,7 m ³ Exterior: 13,5 m ³
SAUNA HEATER	Wood-heated Kota Inari Plus/ Electrically heated Kota Saana
OUTER SURFACE MATERIAL	Spruce plywood and plain sawn spruce
INTERIOR SURFACE MATERIAL	Spruce plywood, plain sawn spruce and red cedar
NUMBER OF PEOPLE	4-6
CONTENTS OF THE DELIVERY	delivered assembled, excluding the roof, which must be installed on site





We cooperate with
the cross-country skier
Katri Lyyntperä.



Warmer feelings.

You have earned your luxury!

You can always recognise Kirami's products from their careful finishing touches. Kirami manufactures the hot tubs from high-quality and durable materials, offering various options to meet the customers' different tastes. The quality also includes the easy maintenance and the practicality of the hot tubs.

Starting the use of a product is simple and easy. Service is taken care of so that the customer can have memorable, high-quality experiences in the Kirami tubs, regardless of season.

Customer satisfaction is our greatest resource!

Kirami is also a safety pioneer

Kirami was the only Finnish hot tub manufacturer to be actively involved in creating the new EU standard EN 17125 for the safety requirements and test methods related to domestic hot tubs. The safety of small children is especially important to Kirami, and the topic has played a central role in the work done on the standard.

Companies in the field as well as safety authorities, such as the Finnish Safety and Chemicals Agency (Tukes) and other European agencies, have been involved in the development. The standard takes safety perspectives, technical details, quality and different kinds of instructions into account. When customers buy a hot tub compliant with this standard, they can be sure that the product is safe.

This is how we meet the requirements of the standard

Cover

The standard pays special attention to the safety of children. A hot tub cover is the most effective way to ensure that children cannot enter the tub without supervision. Adults are nevertheless responsible for the safety of children in the end, and they must monitor the children in the vicinity of the tub and ensure that the cover is locked.

All of Kirami's hot tub models have a suitable high-quality cover that is easy to handle and can be locked either with locks or another effective method. In addition to safety, the cover has other benefits.

- Prevents children from entering the tub without supervision.
- Protects the tub from debris and UV radiation.
- Heats the water faster.
- Keeps the water hot longer.
- Optimises heating the water on the following day.



Steps

The standard requires that the hot tub must have safe steps available as an accessory.

Of course, getting the steps is the customer's decision, but Kirami offers different step models for all of the available hot tubs.

- Allow you to climb safely into and out of the tub.



Grates

One of the most important requirements of the standard is that there must not be any holes inside the tub in which hands, fingers, feet, toes or a head could get stuck under water.

Kirami has already taken this well into account. All models have protective grates in front of the water flow-through holes, which:

- make the hot tub safer
- prevent fingers and toes from getting stuck

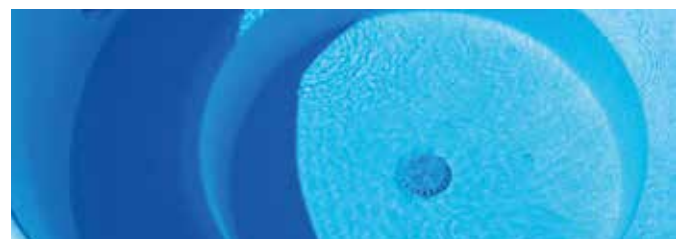

Thermometer and mixing paddle

The standard requires that hot tubs, in which the heating is not based on water circulation and automatic thermostats, must be equipped with a thermometer.

Kirami has taken care of this, too, and it has also taken safety one step further. Before measuring the temperature, the hot surface water needs to be mixed with the cooler water below to ensure that the measurement results are accurate. This can be done easily

with Kirami's mixing paddle. Despite measurements, you should still check the water temperature with your own elbow before stepping into the hot tub!

- The paddle ensures that the water is heated evenly.
- The thermometer shows when the water temperature is suitable.

Heat shield, chimney cap and fireproof plate

The standard also aims to ensure the fire safety of hot tubs and heaters.

The heat shield, chimney cap and fireproof plate promote fire safety. Naturally, Kirami provides all necessary instructions on the minimum distances related to fire safety in accordance with the standard. When heating is done according to the instructions, i.e. the tub is filled with water before starting the heating, Kirami's heaters will not get hot enough to burn, either. Thanks to the free water circulation, the aluminium heater is cooled by water.

- The heat shield protects you from the hot chimney pipe.
- The chimney cap prevents sparks from spreading into the surrounding nature.
- The fireproof plate prevents embers from falling into easily flammable ground.



Minimum distances between hot tubs heated with wood and trees and buildings.

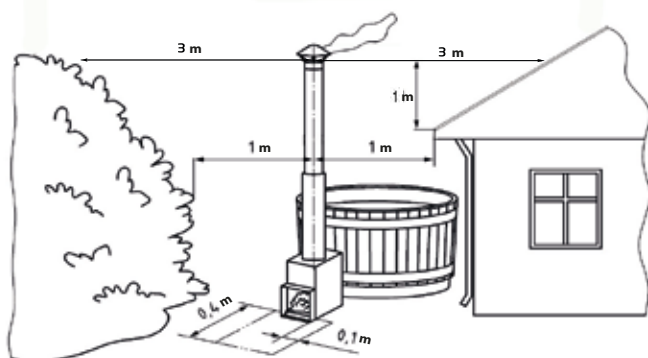

Water hygiene

The standard requires that appropriate instructions for keeping the water clean must be available.

Kirami has taken compliance with this standard, too, even further, because in addition to the instructions, Kirami offers a whole range of water treatment products that meet the standards set for chemicals.

In addition to detailed instructions, suitable water treatment products compliant with the standards set for chemicals are available from Kirami's resellers.



Durable, traceable and recyclable materials

The standard also makes statements on the manufacturing materials and their overall quality.

The Kirami hot tubs and the Outstanding products are made to last, and all hot tubs have a two-year warranty. All materials in a tub can be recycled. The tub heater and the hoops go to metal recycling. The wood, rubber and plastic parts can be recycled to be reused or used as energy-from-waste. Separating the materials at the waste collection will be easier if you have disassembled the tub yourself. When you separate the materials carefully, you will make waste collection easier and reduce the waste fee you need to pay.

- The warranty works reliably.
- You can still get spare parts and equipment for your hot tub years later.
- You can replace your Kirami hot tub without needing to worry about anything.



Safe bathing

Below, you can see explanations of the symbols related to operating safety shown in connection with the hot tub.

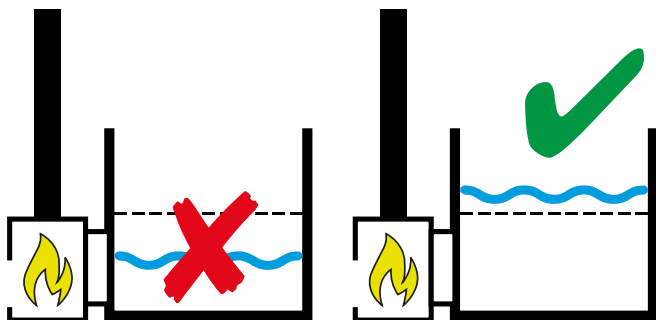

Before starting heating, fill the hot tub with water up to the minimum level, i.e. approximately 5 cm above the upper pipe of the heater.



- Read the instruction manual and safety regulations before use.



- Keep an eye on the children while they are in the hot tub.



- Jumping into the hot tub is prohibited!



- Be careful of the hot surfaces!



Kirami's partners, the actor Ville Haapasalo and the inventor Janne K pylehto

Good to know

Ordering Kirami products



Ordering Kirami has more than 20 resellers all over Europe. You can find your nearest reseller on our website: www.kirami.fi.

The resellers will give you an offer for the products you choose. Time and way of delivery depend on the product you wish to have.

The delivery of the tub can be arranged for the requested address.



Product registration

Remember to register the Kirami product you have purchased on our website. Registration offers you several great benefits. If you wish, you can get tips for using your products and offers related to them. In addition, we will also send a small gift to everyone who registers a Kirami product.



User manuals

Each hot tub and heater includes a user manual. You can also download the latest user manuals from our website.

www.kirami.fi

All rights reserved



www.facebook.com/kiramioy



www.instagram.com/kiramioy



[Kirami Oy Youtube channel](https://www.youtube.com/channel/Kirami Oy)

www.kirami.fi/blog



Warmer feelings.

Kirami Oy

Villiläntie 2, 32730 Sastamala

Finland

info@kirami.fi

www.kirami.fi

