



*Warmer feelings.*

*For those cosy bathing moments*



Hot tubs and saunas in 2022



Kirami provides its customers with high-quality hot tubs, handmade Kirami FinVision -saunas, Outstanding garden products and a wide array of equipment and accessories.

The story of Kirami began 21 years ago, in 2001. The first hot tubs were imported from Sweden, but soon the company launched its own production. In 2006, the company moved to new premises and its product range expanded to include hot tubs made from heat-treated wood. Kirami moved to its current facilities, measuring over 3,300 square metres, in early 2011. The following year, it introduced hot tubs with plastic inner liners and a comprehensive selection of water treatment chemicals to the market.

2015 saw another expansion of the product range; the high-quality Outstanding series focused on BBQs, outdoor wood burners and garden furniture made from robust yet fashionable COR-TEN steel. In 2019, Kirami created its first Kirami FinVision sauna – a model closely connected to nature – and the product line's huge popularity has allowed it to keep growing.

Kirami AB was established in Sweden in February 2020, and the number of resellers increased as several new chains joined in. Furthermore, Kirami has also been part of the Harvia group since 28 May 2021.

In addition to the Finnish market, Kirami manufactures products for export. These days, Kirami's hot tubs and saunas can be enjoyed around Europe, as well as in Japan and the US.

Kirami's mission is to offer top-quality and easy-to-use products that you can feel proud for owning. All the tubs, pools and Kirami FinVision -saunas are handcrafted using carefully selected materials and assembled at Kirami's factory in Sastamala, Finland.

## TABLE OF CONTENTS

|       |   |
|-------|---|
| 4-7   | Product groups                          |
| 8-9   | What is Kirami?                         |
| 10-11 | Tools to help you choose a hot tub      |
| 12-25 | Original                                |
| 26-31 | Comfort                                 |
| 32-35 | Premium                                 |
| 36    | Enjoy your hot tub year round           |
| 38    | Colours and materials                   |
| 40    | Heaters                                 |
| 42    | Steps and drink holders                 |
| 43    | Tubbar 2                                |
| 44    | Covers and locks                        |
| 46    | Carefully thought-out details           |
| 48-51 | Easy water hygiene in Kirami's hot tubs |
| 52    | Kirami is also a forerunner in safety   |
| 55-61 | Kirami FinVision -sauna                 |
| 62    | Caring for your Sauna                   |
| 64    | Kirami FinVision Experience             |
| 66-69 | Outstanding                             |

MADE IN +  
FINLAND



# *Kirami – 21 years of blissful bathing*

Kirami is turning 21 this year, and so last year we celebrated a jubilee. It was an important milestone for us and an eventful year in many ways. Having operated in the sector for over 20 years, we have gained a vast amount of knowledge about the materials and honed our skills and expertise in order to manufacture durable products of high quality for our customers to enjoy.

The most popular hot tubs in 2021 included the low-maintenance **Steady** and the **Family L**, the latter of which has remained a favourite amongst those who enjoy a bigger tub. In addition to that, the smaller **Tiny** series' models have quickly found their users. Tiny's huge success has allowed us to make it even better, and the new shape, better bathing ergonomics, insulated bottom, similar to our other hot tubs, as well as the draining method have made Tiny an increasingly attractive product.

The latest products in this catalogue include the **Dippy dipping tubs**, which will take your bathing experience to that famous next level. In other words, you are guaranteed to find a Kirami hot tub that is the perfect size and has the perfect features.

Our **BioCool water treatment products** offer a chlorine-free option for keeping the bathing water clean. These products are highly popular in Finland, Sweden, France, Germany and the UK, and the list of countries is about to expand this year.

As a result of the high demand for our **Kirami FinVision -saunas**, our **Sauna Factory** has spread into two buildings. Likewise, our product line has grown, and the **Kirami FinVision -sauna Original** is now accompanied by **Kirami FinVision -sauna Nordic misty**, which can be equipped with either a steamer heater or an infrared heater. The model comes with the roof already attached and all the wiring completed. Both models can also be complemented with a changing room, which has its own line of accessories available.

When talking about saunas, you should not forget sauna textiles or our series, designed to provide a complete bathing experience.

*We wish you enjoyable moments browsing our new catalogue!*



A DIVISION OF  
**HARVIA GROUP**



# Original

Kirami Original takes you to the origins of an authentic bathing experience. The high quality of these simple, traditional hot tubs is a result of careful material choices and skilled craftsmanship.

The Original product family includes options for groups of all sizes. **Hazy** is popular amongst first-time hot tub buyers, **Breezy** takes the ease of care to a whole new level and **Woody** appeals to nature lovers with its use of real wood that sets the perfect mood. The new **Dippy** dipping tubs are suited for cooling down, for example after a session in a sauna. **Chill** is shallower than the other models and can therefore be easily transported into smaller gardens, and the ability to sit back in the tub provides a completely new way of relaxing. And as for **Tiny** and **Woody Tiny**, they offer a pleasant setting for two people to bathe together.

The Kirami Original hot tubs are 100% Finnish.

Pages: 12-25



# Premium

The Premium series is Kirami's flagship. The products' design, efficiency and comfort of use are in a class of their own. The Premium product family includes the luxurious **Pearly**, which is also available with a truly stunning outer surface made from copper.

Another member of the Premium family is the **Red Cedar Premium** hot tub, and a completely new hot tub design called **Steady Flow** will be launched later in the spring, featuring water jets.

The Premium products will maintain their appealing looks year after year, even in challenging conditions.

The Kirami Premium hot tubs are 100% Finnish.

Pages: 32-35





# Comfort

Kirami Comfort offers an enjoyable and effortless bathing experience. These plastic tubs are easy to care for and the perfect choice for active hot tubbers.

One of the Comfort series favourites, **Steady**, is great for people who appreciate comfort and modern style, while the **Family** hot tubs offer plenty of options for smaller and larger families. They are designed with families, the elderly and people with reduced mobility in mind, making them as easy and safe as possible to get into and out of.

The Kirami Comfort hot tubs are 100% Finnish.

Pages: 26–31





# Kirami FinVision -sauna

**Kirami FinVision -saunas** are a fine example of masterful craftsmanship. The interiors are carefully designed, both in terms of appearance and practicality. Bathers can immerse themselves in the cosy atmosphere and feel closely connected to the surrounding nature, thanks to the large windows. The benches can be lifted up, which is handy when cleaning the sauna. **Kirami FinVision -sauna Original** and our latest series, **Kirami FinVision -sauna Nordic misty**, come with several heater options. A changing room can also be added to both saunas, perhaps complemented with additional extras such as a bench, LED lights and a clothes hanger.

Pages: 55-61



## Outstanding

The Outstanding products were created out of a genuine need. We wanted to design durable, functional and aesthetic products, allowing our customers to enjoy life both in urban and rural settings. **Roasty Boss** is a beast of a BBQ that meets the needs of even the most demanding of chefs, especially if you equip it with an **Iron Monster** frying plate. Together they make a powerful setup for cooking a meal for a group of any size. The **Roasty Boss pot** can also serve as a fire pit, allowing you to enjoy those mesmerising live flames. The other accessories include a beautifully patinated leather apron, **Leather Patron**, and **Heat It Up charcoal** that guarantees the best bed of embers. The latest product in the Outstanding series is top chef Jesse Söderlund's cookbook, **LET'S EAT OUT**, which contains an abundance of delicious recipes for outdoor cooking and eating. For outdoor decor, the Outstanding series offers the highly functional and truly multi-purpose **Triholdy**. Made from CORTEN steel, Triholdy can be used as a space divider, a rack for firewood or a planter, to name a few options. Imagination is the limit.

Pages: 66-69





## *Kirami FinVision Experience*

A close connection to nature and enjoying life are elements that feature heavily in all of Kirami's products, including the **Kirami FinVision Experience** series, spanning across the entire sauna experience. The comfortable cotton bench towels, soft and generously sized towels made from honeycomb fabric, and the elegant and luxurious bathrobes made from 100% cotton make bathing ever more enjoyable. In addition to these, the product line includes a washbag made from recycled sailcloth and fun tub hats that are particularly useful in the hot tub and available in various designs, guaranteed to suit all tastes.

Pages: 64-65





# What Kirami is



## *Easy to buy*

- A reseller network within reach
- Wide range of products
- Can be placed almost anywhere
- Appearance and placement can be tested with a 3D application
- Can be delivered anywhere
- Delivered already assembled; the customer only needs to attach the heater and the chimney
- Clear, comprehensive instructions
- The blogs and the FAQ page have answers to any questions you may have
- The online shop is always open
- On the website, everything necessary can be collected on a convenient product card, which can be used to help with the purchase

## *Safe to use*

- All chimney packages include a heat shield
- Thanks to the water jacket, the heater never becomes burning hot
- Lockable covers
- The water flow-through holes of the tubs are covered with protective grates
- Lights installed safely at the factory
- 2 year product warranty
- Sturdy and safe steps that fit all hot tubs
- Models that take the needs of families in particular into account
- Two different types of heaters: wood and electric
- Fireproof hearth plate

## *Effortless to equip*

- Suitable covers, steps and drink holders available for all models
- Plenty of accessories, such as neck rests and led lights

## *Easy to care*

- Easy to empty completely out of water
- Simple to keep clean
- The heater is easy to clean
- An anode rod protects the heater from corrosion and ensures a long service life
- The EPS base is light and weatherproofed
- Outer surface options that require no maintenance: EcoPlank, EcoStripe and Copper
- The cover protects the tub from rubbish and keeps the bathwater warm



# A responsible choice

- Made in Finland
- Standardised
- Responsible manufacturer
- The whole lifespan has been considered: longlasting and recyclable
- Strong brand



Warmer feelings.

+



+



+

Standard  
EN 17125



You can download it from the App Store (Kirami Hot Tub Designer)



or Google Play (Kirami).



### Kirami Hot Tub Designer

Build the hot tub you want in the application and see how it fits in your own yard.

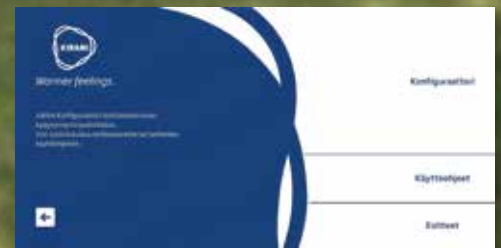
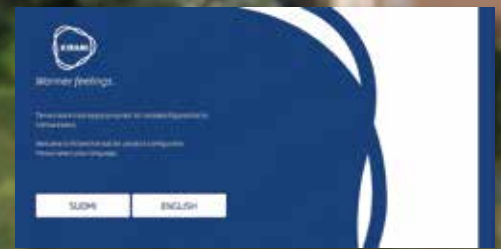

## Tools to help you with choosing a hot tub

### Kirami Hot Tub Designer

Kirami Hot Tub Designer makes finding the perfect hot tub for you and your family not only easy, but also fun.

Browse Kirami's range of hot tubs and choose the hot tub and heater with the size and features that suit you best from among several options.

Next you can compare the interior and exterior materials available for the hot tub of your choice. You can try out the different options and combinations and see immediately what your hot tub would look like.

After finding a suitable hot tub and the materials you like best, you can try and see what the hot tub would look like in its natural habi-

tat - your own yard or terrace. On the phone screen, move the image of your chosen hot tub to the place where you intended to put the hot tub and take a picture. Now you have a convenient way of showing your plans to the other members of your family, for example.

Finish your hot tub by adding the accessories you want, such as steps and a drink holder. The system always suggests accessories suitable specifically for the package you have selected, so you cannot choose wrong.

The summary includes all important information on the products you have selected. When you are happy with your choices, fill in your own information and send us the request for a quotation!



## Product cards

You can also choose the hot tub that suits you best on Kirami's website.

Browse the product pages of different hot tub models, find the one you like best and try out different kinds of tub colours and outer surface materials to see what they would look like on your hot tub. The product page of each hot tub always has only the options available for the hot tub in question, which means that you cannot accidentally

pick a heater or an accessory that is incompatible with the model you are considering. The system also ensures that all the necessary elements of a well-working tub are selected.

Once you are happy with the hot tub model and accessories you have chosen, you can download a product card of your future hot tub as a PDF file. Then you can print out the card, go to your nearest reseller and order the hot tub of your dreams.

### Kirami Original Breezy M

#### Cult-si ST-Coal Black, Light Gray

The Original product range's Breezy truly is an easy-care product with inside plastic. This enduring model is suitable for all purposes, making it a good choice for any situation. Its size makes Breezy M suitable for the average family, or why not a get-together with a small group of friends! As additional equipment LED lighting is an option that highlights the plastic's colour. Factory fitted LED lighting creates a fabulous atmosphere in the evening hours.

The hot tub is heated with an external grey Cult-si heater, suitable for heating small tubs. It is made out of high-quality marine-grade aluminium. The cover shell is made out of Finnish spruce panels stained with a dark coal tint, and it keeps its attractive appearance for a long time. Light gray is velvety smooth and delicate dotted isle colour. The soft, vibrant gray of the reactor is always timeless and elegant, and it blends in beautifully with the environment.

The barrel diameter is 170 cm and water volume is 240 litres. It is suitable for 4-6 people. The dry weight of the hot tub is 132 kg. The gross heat output of the Cult-si stove is 26 kW and the net heat output transferred to the water is 22 kW.

#### Technical Info

|                    |                    |
|--------------------|--------------------|
| CAPACITY (PERSONS) | 4-6                |
| FILLAGE VOLUME     | 1000               |
| WATER CAPACITY     | 1240l              |
| OUTER DIAMETER     | 170 cm             |
| HEIGHT (TUB)       | 110 cm             |
| DEPTH              | 91 cm              |
| WEIGHT             | 132 kg             |
| PRODUCT LENGTH     | 258 cm             |
| PRODUCT WIDTH      | 170 cm             |
| PRODUCT HEIGHT     | 210 cm             |
| PRODUCT CODE       | OBGGT1900CUL75H-CB |



6430036756195

#### Also get accessories

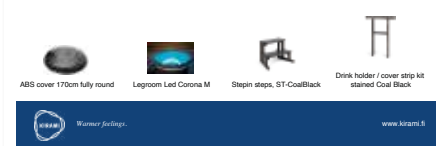

6430036756195



6430036756195



6430036756195

www.kirami.fi

www.kirami.fi

www.kirami.fi

www.kirami.fi

www.kirami.fi

www.kirami.fi

www.kirami.fi

www.kirami.fi

www.kirami.fi

www.kirami.fi

www.kirami.fi

www.kirami.fi

www.kirami.fi

www.kirami.fi

www.kirami.fi

www.kirami.fi

www.kirami.fi

www.kirami.fi

www.kirami.fi

www.kirami.fi

www.kirami.fi

www.kirami.fi

www.kirami.fi

www.kirami.fi

www.kirami.fi

www.kirami.fi

www.kirami.fi

www.kirami.fi

www.kirami.fi

www.kirami.fi

www.kirami.fi

www.kirami.fi

www.kirami.fi

www.kirami.fi

www.kirami.fi

www.kirami.fi

www.kirami.fi

www.kirami.fi

www.kirami.fi

www.kirami.fi

www.kirami.fi

www.kirami.fi

www.kirami.fi

www.kirami.fi

www.kirami.fi

www.kirami.fi

www.kirami.fi

www.kirami.fi

www.kirami.fi

www.kirami.fi

www.kirami.fi

www.kirami.fi

www.kirami.fi

www.kirami.fi

www.kirami.fi

www.kirami.fi

www.kirami.fi

www.kirami.fi

www.kirami.fi

www.kirami.fi

www.kirami.fi

www.kirami.fi

www.kirami.fi

www.kirami.fi

www.kirami.fi

www.kirami.fi

www.kirami.fi

www.kirami.fi



## FAQ, blog posts and videos

Those who have purchased a Kirami hot tub are never left alone with any questions they may have. There are answers, instructions and tips available for practically any situation.

The link to the FAQ (or Frequently Asked Questions) section can be found on nearly every page on Kirami's website. Whether your question was about transporting and installing a hot tub, heating, keeping the water clean or winter storage, the FAQ pages have a thorough discussion of the topic, often with an instructive video.

Kirami's blog posts vary from customer stories to presenting new products as well as in-depth discussions of topics that interest hot tub users. The blog posts contain a vast number of excellent tips and ideas that help you make your bathing moments more enjoyable than ever.

In the manuals section of our website, we have collected both practical how-to videos as well as atmospheric feeling videos. The clear and instructive how-to videos tell you how to install and use a hot tub. We have thought about everything in order to make your life with a Kirami hot tub as enjoyable as possible!

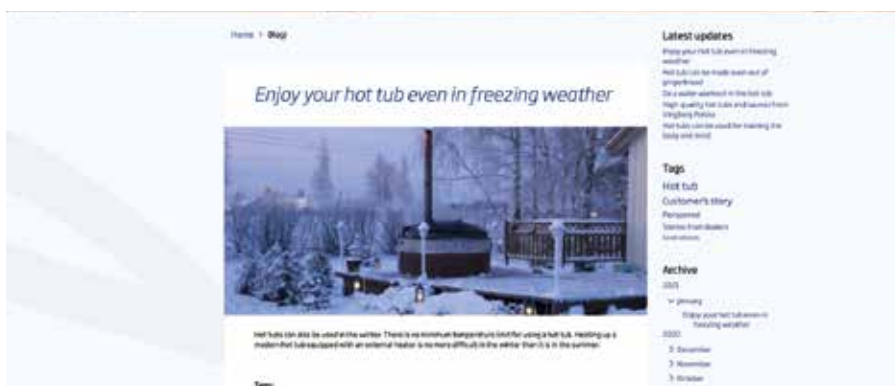





Original

*Quickly heated Chill for  
perfect relaxation.*







# Chill

**M**  
 3-4

Chill is a new way of hot tubbing. Its seat is low, offering an entirely new way of relaxing in the tub, and the reclining position is perfect for adults to enjoy a lazy soak. Chill is also great for children to splash around in. The shallow tub is elegant yet sturdy. This makes it the perfect choice for a small garden, as it can easily fit through a narrow gate or doorway. Moreover, the hot tub's small volume means that filling it is quick work and heating the water takes little firewood.

External colours:



Internal colours:



|                               | <b>M</b>                               |
|-------------------------------|--|
| <b>WATER CAPACITY</b>         | 1170 l                                 |
| <b>MINIMUM WATER CAPACITY</b> | 490 l                                  |
| <b>HEATER</b>                 | MICU                                   |
| <b>DIAMETER</b>               | 170 cm                                 |
| <b>DEPTH</b>                  | 65 cm                                  |
| <b>HEIGHT OF THE TUB</b>      | 80 cm                                  |
| <b>BENCH</b>                  | Built in 5 cm heigh, circles the tub   |
| <b>WEIGHT</b>                 | Weight of the tub in the image: 70 kg* |
| <b>WATER OUTLET</b>           | 2 1/2" female + coupling 38 mm         |
| <b>CHIMNEY</b>                | Ø 120 mm, 1,5 m + Hat                  |
| <b>CHIMNEY HEATSHIELD</b>     | 1 m                                    |
| <b>FITTING COVER MODELS</b>   | Plastic cover / Insulated cover        |

\*Tub weight is without the heater and chimney. You will find weights of chimney's and heaters on pages 40-41.

**Q: What kind of a base/foundation is needed for the hot tub?**

**A:** A level base that supports the full weight on the whole area of the hot tub must be selected as the base/foundation for installing the hot tub. The surface can be evened out with stone chippings, for example. If you want to have a more solid foundation, you can cast one from concrete or use ready-made slabs. Keeping the area surrounding the tub free from vegetation is also recommended. See the instructions!





Original

*Breezy - always a good choice*







# Breezy

**M**  
 4-6

Our Original Breezy is a prime example of ease of care, thanks to its single-coloured plastic inner liner. Safe LED lighting is available as an accessory to bring out the tub's own colour. This durable model is suitable for all purposes, making it a good choice for any setting. The roomy Breezy M is suitable for an average family or a get-together with friends.



**External colours:**

Coal Black

Dark Walnut

**Internal colours:**

Light Gray

Polar Blue

LED

LED

|                               | <b>M</b>                               |
|-------------------------------|--|
| <b>WATER CAPACITY</b>         | 1540 l                                 |
| <b>MINIMUM WATER CAPACITY</b> | 650 l                                  |
| <b>HEATER</b>                 | CULT                                   |
| <b>DIAMETER</b>               | 170 cm                                 |
| <b>DEPTH</b>                  | 91 cm                                  |
| <b>HEIGHT OF THE TUB</b>      | 110 cm                                 |
| <b>BENCH</b>                  | Built-in, circles the tub              |
| <b>WEIGHT</b>                 | Weight of the tub in the image: 94 kg* |
| <b>WATER OUTLET</b>           | 2 1/2" female + coupling 38 mm         |
| <b>CHIMNEY</b>                | Ø 120 mm, 1,5 m + Hat                  |
| <b>CHIMNEY HEATSHIELD</b>     | 1 m                                    |
| <b>FITTING COVER MODELS</b>   | Plastic cover / Insulated cover        |

\*Tub weight is without the heater and chimney. You will find weights of chimney's and heaters on pages 40-41.





Original

*The elegant Hazy is perfect  
for every location*







# Hazy

**M**  
 4-6

The easy-care hot tub offers comfort and modern style. Hazy is related to the popular Steady. We picked the features for Hazy that make it a perfect choice for people who are thinking about their first hot tub, for example. If you want a simple, straightforward hot tub that nevertheless offers comfort and ease of use, Hazy is just the thing for you. The raised seat design makes getting into the tub easier, the bench corners can be used as back rests, and the bench also acts as an arm rest. The smooth plastic surfaces of the tub in light colours make it possible to install safe LED lights available as accessories. The heater is an external CULT in shades of grey. The outer shell is made of durable Finnish spruce panels stained with a dark brown or black tint. The translucent grey interior is suitable for many different environments.



|                               | <b>M</b>                               |
|-------------------------------|--|
| <b>WATER CAPACITY</b>         | 1420 l                                 |
| <b>MINIMUM WATER CAPACITY</b> | 600 l                                  |
| <b>HEATER</b>                 | CULT                                   |
| <b>DIAMETER</b>               | 170 cm                                 |
| <b>DEPTH</b>                  | 90 cm                                  |
| <b>HEIGHT OF THE TUB</b>      | 107 cm                                 |
| <b>BENCH</b>                  | Built-in, circles the tub              |
| <b>WEIGHT</b>                 | Weight of the tub in the image: 79 kg* |
| <b>WATER OUTLET</b>           | 2 1/2" female + coupling 38 mm         |
| <b>CHIMNEY</b>                | Ø 120 mm, 1,5 m + Hat                  |
| <b>CHIMNEYHEATSHIELD</b>      | 1 m                                    |
| <b>FITTING COVER MODELS</b>   | Plastic cover / Insulated cover        |

\*Tub weight is without the heater and chimney. You will find weights of chimney's and heaters on pages 40-41.





Original

*Small size,  
great enjoyment  
- Tiny and Woody Tiny*



**Revamped  
model  
2022**



# Tiny

Original Tiny's oval shape has been streamlined and the tub's bathing ergonomics have been improved. Caring for this graceful little hot tub is effortless, and it features an inner liner and two shaped seats, making it ideal for one or two people. Light in weight and compact in size, the tub is easy to install in a small garden or on a patio, and thanks to its small volume, it heats up quickly, allowing you to enjoy a spot of luxury even on a busy weekday evening. Safe pre-installed LED lighting is available for the tub to bring out its own colour and create a magical atmosphere for spa sessions later in the season when the nights begin to draw in.



External colours:



Internal colours:



# Woody Tiny

Woody Tiny offers the authentic feel of wood in a compact size. It is our smallest solid-wood hot tub, ideal for both cute little gardens and patios. The hot tub's size and upgraded shape make Woody Tiny the optimum option for couples and settings where water consumption must be kept to a minimum. Thanks to the short heating time and small water volume, you can have a relaxing dip even on an otherwise busy evening. Woody Tiny offers everything you need for a great, wood-heated hot tub experience. In addition to Woody Tiny, made from heat-treated wood, our Original series includes Premium, made from thuja.



Materials:



|                               | S                                   |
|-------------------------------|-------------------------------------|
| <b>WATER CAPACITY</b>         | 615 l                               |
| <b>MINIMUM WATER CAPACITY</b> | 315 l                               |
| <b>HEATER</b>                 | CULT                                |
| <b>DIAMETER</b>               | 170 cm                              |
| <b>DEPTH</b>                  | 83 cm                               |
| <b>HEIGHT OF THE TUB</b>      | 98 cm                               |
| <b>LENGTH</b>                 | 71,5 cm                             |
| <b>BENCH</b>                  | Shaped seat at both ends of the tub |
| <b>WEIGHT</b>                 | 50 kg*                              |
| <b>WATER OUTLET</b>           | 1" female + coupling 32 mm          |
| <b>CHIMNEY</b>                | Ø 120 mm, 1,5 m + Hat               |
| <b>CHIMNEY HEATSHIELD</b>     | 1 m                                 |
| <b>FITTING COVER MODELS</b>   | Insulated cover                     |

|                               | ORIGINAL WOODY TINY(TW)                        | PREMIUM WOODY TINY (RC)                        |
|-------------------------------|--|--|
| <b>WATER CAPACITY</b>         | 760 l  | 760 l  |
| <b>MINIMUM WATER CAPACITY</b> | 580 l  | 580 l  |
| <b>HEATER</b>                 | MICU   | MICU   |
| <b>DIAMETER</b>               | 170 cm   | 170 cm   |
| <b>DEPTH</b>                  | 85 cm  | 85 cm  |
| <b>HEIGHT OF THE TUB</b>      | 98 cm  | 98 cm  |
| <b>LENGTH</b>                 | 71,5 cm  | 71,5 cm  |
| <b>BENCH</b>                  | 2-boards in each end of the hot tub            | 2-boards in each end of the hot tub            |
| <b>WEIGHT</b>                 | 100 kg*  | 90 kg*   |
| <b>WATER OUTLET</b>           | Ball valve 1 1/2" sk/sk + hose connector 38 mm | Ball valve 1 1/2" sk/sk + hose connector 38 mm |
| <b>CHIMNEY</b>                | Ø 120 mm, 1,5 m + Hat                          | Ø 120 mm, 1,5 m + Hat                          |
| <b>CHIMNEY HEATSHIELD</b>     | 1 m  | 1 m  |
| <b>FITTING COVER MODELS</b>   | Insulated cover                                | Insulated cover                                |

\*Tub weight is without the heater and chimney. You will find weights of chimney's and heaters on pages 40-41.





Original

*Take a dip in Tiny Dippy  
- alone or together*



# Tiny Dippy

We have received a lot of queries about hot tubs without a heater, and because we always listen to our customers with a keen ear we decided to create a new product line of so-called dipping tubs. A dipping tub is a great option for cooling down between sessions in the sauna or on a warm summer's day. It is also the perfect choice for anyone interested in winter swimming. The dimensions and features of Tiny Dippy are exactly the same as those of the heated version, apart from the actual heater and the holes necessary to install one.



External colours:



Internal colours:



Materials:

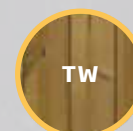

|                               | S                                   |
|-------------------------------|-------------------------------------|
| <b>WATER CAPACITY</b>         | 615 l                               |
| <b>MINIMUM WATER CAPACITY</b> | 315 l                               |
| <b>DIAMETER</b>               | 170 cm                              |
| <b>DEPTH</b>                  | 83 cm                               |
| <b>HEIGHT OF THE TUB</b>      | 98 cm                               |
| <b>LENGTH</b>                 | 71,5 cm                             |
| <b>BENCH</b>                  | Shaped seat at both ends of the tub |
| <b>WEIGHT</b>                 | 50 kg*                              |
| <b>WATER OUTLET</b>           | 1" female + coupling 32 mm          |
| <b>FITTING COVER MODELS</b>   | Insulated cover                     |

# Woody Tiny Dippy

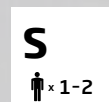

Would you like a dip in refreshing water on a hot day, cool down between sessions in the sauna or enjoy the feeling you get from winter swimming even when the weather is warm? Kirami's dipping tub is the answer. Woody Tiny Dippy has the same gracefully elegant design as Woody Tiny, but it comes without a heater. Enjoy an invigorating dip by yourself or with another!



|                               | ORIGINAL WOODY TINY (TW)                       | PREMIUM WOODY TINY (RC)                        |
|-------------------------------|--|--|
| <b>WATER CAPACITY</b>         | 760 l  | 760 l  |
| <b>MINIMUM WATER CAPACITY</b> | 580 l  | 580 l  |
| <b>DIAMETER</b>               | 170 cm   | 170 cm   |
| <b>DEPTH</b>                  | 85 cm  | 85 cm  |
| <b>HEIGHT OF THE TUB</b>      | 98 cm  | 98 cm  |
| <b>LENGTH</b>                 | 71,5 cm  | 71,5 cm  |
| <b>BENCH</b>                  | 2-boards in each end of the hot tub            | 2-boards in each end of the hot tub            |
| <b>WEIGHT</b>                 | 100 kg*  | 90 kg*   |
| <b>WATER OUTLET</b>           | Ball valve 1 1/2" sk/sk + hose connector 38 mm | Ball valve 1 1/2" sk/sk + hose connector 38 mm |
| <b>FITTING COVER MODELS</b>   | Insulated cover                                | Insulated cover                                |





Original

*Woody calms you down  
when life gets hectic*





# Original Woody

|                     |                     |                       |
|---------------------|---------------------|-----------------------|
| <b>M</b><br>♀ x 4-6 | <b>L</b><br>♀ x 6-8 | <b>XL</b><br>♀ x 8-12 |
|---------------------|---------------------|-----------------------|

Original Woody hot tubs are made of Thermowood, which creates the original wooden feel and authentic atmosphere. These models offer a great choice with different heaters, from the traditional SUB underwater heater to the extremely powerful TUBE heater. The wide range of the collection makes it easy to find a suitable model to fit your patio.

Materials:



# Premium Woody

|                     |                     |
|---------------------|---------------------|
| <b>M</b><br>♀ x 4-6 | <b>L</b><br>♀ x 6-8 |
|---------------------|---------------------|

The Woody Premium hot tubs are made of the luxuriously stylish Red Cedar that creates a genuine, natural mood for spa moments. The wood is light, with top quality rot resistance. The Woody Premium hot tubs are finished by hand, and the extremely efficient CUBE and TUBE heaters make everything complete.

Materials:



|                               | M  | L  | XL   |
|-------------------------------|--|--|--|
| <b>WATER CAPACITY</b>         | 1860 l   | 2600 l   | 3180 l   |
| <b>MINIMUM WATER CAPACITY</b> | 1460 l   | 2060 l   | 2800 l   |
| <b>HEATER</b>                 | SUB/CUBE/TUBE                                  | SUB/CUBE/TUBE                                  | TUBE   |
| <b>DIAMETER</b>               | 170 cm   | 200 cm   | 220 cm   |
| <b>DEPTH</b>                  | 95 cm  | 95 cm  | 95 cm  |
| <b>HEIGHT OF THE TUB</b>      | 108 cm   | 108 cm   | 108 cm   |
| <b>BENCH</b>                  | Two planks around                              | Two planks around                              | Two planks around                              |
| <b>WEIGHT</b>                 | 140 kg*  | 160 kg*  | 180 kg*  |
| <b>WATER OUTLET</b>           | Ball valve 1 1/2" sk/sk + hose connector 38 mm | Ball valve 1 1/2" sk/sk + hose connector 38 mm | Ball valve 1 1/2" sk/sk + hose connector 38 mm |
| <b>CHIMNEY</b>                | Ø 150 mm, 2 m + Hat                            | Ø 150 mm, 2 m + Hat                            | Ø 150 mm, 2 m + Hat                            |
| <b>CHIMNEY HEATSHIELD</b>     | 1 m  | 1 m  | 1 m  |
| <b>FITTING COVER MODELS</b>   | Plastic cover / Insulated cover                | Insulated cover                                | Insulated cover                                |

|                               | M  | L  |
|-------------------------------|--|--|
| <b>WATER CAPACITY</b>         | 1860 l   | 2600 l   |
| <b>MINIMUM WATER CAPACITY</b> | 1460 l   | 2060 l   |
| <b>HEATER</b>                 | CUBE/TUBE                                      | CUBE/TUBE                                      |
| <b>DIAMETER</b>               | 170 cm   | 200 cm   |
| <b>DEPTH</b>                  | 95 cm  | 95 cm  |
| <b>HEIGHT OF THE TUB</b>      | 108 cm   | 108 cm   |
| <b>BENCH</b>                  | Two planks around                              | Two planks around                              |
| <b>WEIGHT</b>                 | 120 kg*  | 140 kg*  |
| <b>WATER OUTLET</b>           | Ball valve 1 1/2" sk/sk + hose connector 38 mm | Ball valve 1 1/2" sk/sk + hose connector 38 mm |
| <b>CHIMNEY</b>                | Ø 150 mm, 2 m + Hat                            | Ø 150 mm, 2 m + Hat                            |
| <b>CHIMNEY HEATSHIELD</b>     | 1 m  | 1 m  |
| <b>FITTING COVER MODELS</b>   | Plastic cover / Insulated cover                | Insulated cover                                |

\*Tub weight is without the heater and chimney. You will find weights of chimney's and heaters on pages 40-41.





Original

*Cool down in a genuine  
wooden tub, Woody Dippy*





# Original Woody Dippy

**M**

♣ x 4-6

The Woody hot tub is also available without a heater and its installation holes. This allows it to serve as a heavenly refreshing dipping tub on a hot summer's day or after a vigorous session in the sauna. Cold water can also mimic the feel of winter swimming, delivering the same health benefits year round. After all, using cold water to recover is a widely recognised method amongst athletes. The Original product family's Woody Dippy is made from heat-treated wood.

Materials:



|                               | <b>M</b>                                       |
|-------------------------------|--|
| <b>WATER CAPACITY</b>         | 1860 l   |
| <b>MINIMUM WATER CAPACITY</b> | 1460 l   |
| <b>DIAMETER</b>               | 170 cm   |
| <b>DEPTH</b>                  | 95 cm  |
| <b>HEIGHT OF THE TUB</b>      | 108 cm   |
| <b>BENCH</b>                  | Two planks around                              |
| <b>WEIGHT</b>                 | 140 kg   |
| <b>WATER OUTLET</b>           | Ball valve 1 1/2" sk/sk + hose connector 38 mm |
| <b>FITTING COVER MODELS</b>   | Plastic cover / Insulated cover                |

# Premium Woody Dippy

**M**

♣ x 4-6

The Premium product family's Woody Dippy is otherwise similar to Original Woody Dippy, but the material used in its construction is stunningly beautiful and luxurious red cedar. The superb workmanship of Premium Woody Dippy allows you to enjoy that magnificent feel of real wood.

Materials:



|                               | <b>M</b>                                       |
|-------------------------------|--|
| <b>WATER CAPACITY</b>         | 1860 l   |
| <b>MINIMUM WATER CAPACITY</b> | 1460 l   |
| <b>DIAMETER</b>               | 170 cm   |
| <b>DEPTH</b>                  | 95 cm  |
| <b>HEIGHT OF THE TUB</b>      | 108 cm   |
| <b>BENCH</b>                  | Two planks around                              |
| <b>WEIGHT</b>                 | 120 kg   |
| <b>WATER OUTLET</b>           | Ball valve 1 1/2" sk/sk + hose connector 38 mm |
| <b>FITTING COVER MODELS</b>   | Plastic cover / Insulated cover                |





Comfort

*Family M - practical comfort*





# Family M

**M**  
 x 3-5

The Family hot tub has been developed to take the needs of children, elderly people and disabled people into account. In addition to practicality, its development has focused increasingly on safety. The inner step makes it easier to climb into the tub. It also makes the height of the tub more comfortable and relaxed for children and shorter people.

External colours:

Coal Black

TW

EP Night Black

EP Mocca

RC

Internal colours:

Stone Grey

Soft Beige

Ocean Blue

LED

LED

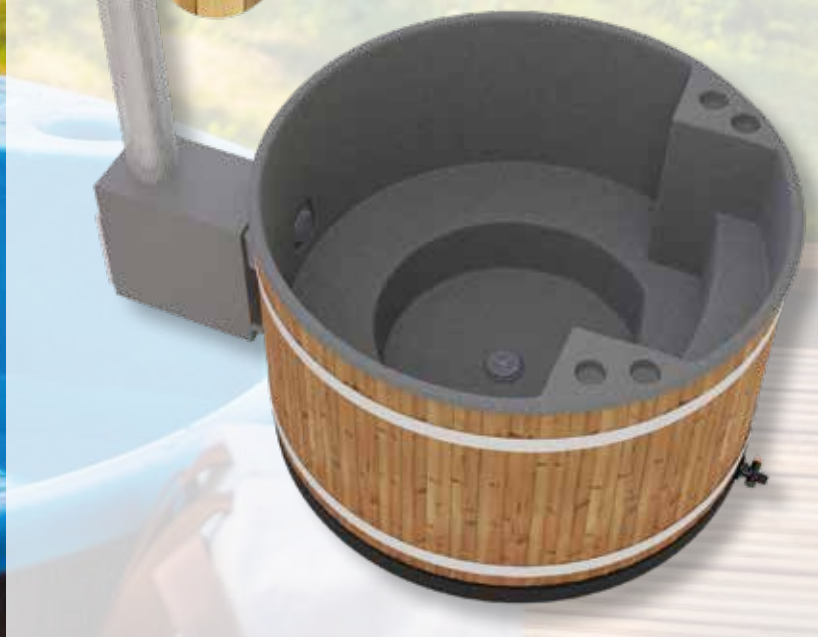

|                               | <b>M</b>                               |
|-------------------------------|--|
| <b>WATER CAPACITY</b>         | 1370 l                                 |
| <b>MINIMUM WATER CAPACITY</b> | 590 l                                  |
| <b>HEATER</b>                 | CULT-Silver / MACU                     |
| <b>DIAMETER</b>               | 170 cm                                 |
| <b>DEPTH</b>                  | 91 cm                                  |
| <b>HEIGHT OF THE TUB</b>      | 110 cm                                 |
| <b>BENCH</b>                  | Built-in, circles the tub              |
| <b>WEIGHT</b>                 | Weight of the tub in the image: 85 kg* |
| <b>WATER OUTLET</b>           | 2 1/2" female + coupling 38 mm         |
| <b>CHIMNEY</b>                | Ø 120 mm, 1,5 m + Hat                  |
| <b>CHIMNEY HEATSHIELD</b>     | 1 m                                    |
| <b>FITTING COVER MODELS</b>   | Plastic cover / Insulated cover        |

\*Tub weight is without the heater and chimney. You will find weights of chimney's and heaters on pages 40-41.





Comfort

## *Family L - bathing experiences for families of all sizes*



**Q: How can I move the hot tub?**

**A:** Hot tubs are primarily delivered with all accessories packed inside the tub, which means that the weight of the package can exceed 200 kg. The tub itself is relatively light. When you remove the heater and other loose parts from inside the package, the remaining weight ranges from 100 to 160 kg depending on the model, meaning that the tub can be carried by 3-4 people.



**THE  
POPULAR  
FAVOURITE**

# Family L

**L**  
 x 6-8

The Comfort series now includes the new Family L hot tub, which has enough space for even a group of bathers with the widest shoulders. The features of the tub are just as userfriendly as those of the M-size Family. The tub has a velvety smooth dotted blue, beige or grey interior surface, and there are various colour and material options for the exterior surface. The TUBE and CUBE heaters ensure fast and efficient heating.

**External colours:**



**Internal colours:**



|                               | <b>L</b>                                |
|-------------------------------|---|
| <b>WATER CAPACITY</b>         | 1930 l                                  |
| <b>MINIMUM WATER CAPACITY</b> | 722 / 1050 l                            |
| <b>HEATER</b>                 | CUBE / TUBE                             |
| <b>DIAMETER</b>               | 200 cm                                  |
| <b>DEPTH</b>                  | 91 cm                                   |
| <b>HEIGHT OF THE TUB</b>      | 110 cm                                  |
| <b>BENCH</b>                  | Built-in, circles the tub               |
| <b>WEIGHT</b>                 | Weight of the tub in the image: 140 kg* |
| <b>WATER OUTLET</b>           | 2 1/2" female + coupling 38 mm          |
| <b>CHIMNEY</b>                | Ø 150 mm, 2 m + Hat                     |
| <b>CHIMNEY HEATSHIELD</b>     | 1 m                                     |
| <b>FITTING COVER MODELS</b>   | Insulated cover                         |

\*Tub weight is without the heater and chimney. You will find weights of chimney's and heaters on pages 40-41.





Comfort

## *Steady - modern comfort*

**Q: Can you use the hot tub in the winter?**

**A:** You can use your hot tub normally in winter, provided that you take proper care of heating the water and remember to drain the tub after use. Please keep in mind that water that splashed around the hot tub can create a slipping hazard.

Kirami's partner, the actor Ville Haapasalo.



**THE  
POPULAR  
FAVOURITE**



# Steady

**M**  
4-6

Our hot tubs in the Comfort series are modern in style and offer cosy and carefree bathing. Steady's seat has been designed to make it easy to get into the tub. In addition to the familiar surface materials, Steady can be equipped with a maintenance-free EcoPlank outer shell. The smooth and translucent plastic surfaces allow Kirami's safe LED lights to be installed in all the Steady hot tub colour options.



|                               | <b>M</b>                               |
|-------------------------------|--|
| <b>WATER CAPACITY</b>         | 1420 l                                 |
| <b>MINIMUM WATER CAPACITY</b> | 600 l                                  |
| <b>HEATER</b>                 | MACU / CUBE                            |
| <b>DIAMETER</b>               | 170 cm                                 |
| <b>DEPTH</b>                  | 90 cm                                  |
| <b>HEIGHT OF THE TUB</b>      | 107 cm                                 |
| <b>BENCH</b>                  | Built-in, circles the tub              |
| <b>WEIGHT</b>                 | Weight of the tub in the image: 92 kg* |
| <b>WATER OUTLET</b>           | 2 1/2" female + coupling 38 mm         |
| <b>CHIMNEY</b>                | Ø 150 mm, 2 m + Hat                    |
| <b>CHIMNEY HEATSHIELD</b>     | 1 m                                    |
| <b>FITTING COVER MODELS</b>   | Plastic cover / Insulated cover        |

\*Tub weight is without the heater and chimney. You will find weights of chimney's and heaters on pages 40-41.





Premium

*Pearly - when you really  
want to pamper yourself*





# Pearly

**M**  
 x 4-6

Premium Pearly is the optimal choice for bathers who value quality and ease of care. The tub's glossy, champagne-coloured inner liner made from ABS plastic is amongst the highest class of hot tubs. Other surface materials include elegant copper that brings out the hot tub's shape, adds style to the outer shell and guarantees a gracefully aging, maintenance-free appearance.



External colours:

- RC
- ME Copper
- ES Night-Black
- ES Mocca

Internal colours:

- Champagne LED

Over time, the copper becomes patinated and elegantly greenish.

|                               | M                                      |
|-------------------------------|--|
| <b>WATER CAPACITY</b>         | 1420 l                                 |
| <b>MINIMUM WATER CAPACITY</b> | 600 l                                  |
| <b>HEATER</b>                 | CUBE                                   |
| <b>DIAMETER</b>               | 172 cm                                 |
| <b>DEPTH</b>                  | 90 cm                                  |
| <b>HEIGHT OF THE TUB</b>      | 107 cm                                 |
| <b>BENCH</b>                  | Built-in, circles the tub              |
| <b>WEIGHT</b>                 | Weight of the tub in the image: 70 kg* |
| <b>WATER OUTLET</b>           | 2 1/2" female + coupling 38 mm         |
| <b>CHIMNEY</b>                | Ø 150 mm, 2 m + Hat                    |
| <b>CHIMNEY HEATSHIELD</b>     | 1 m                                    |
| <b>FITTING COVER MODELS</b>   | Insulated cover                        |

\*Tub weight is without the heater and chimney. You will find weights of chimney's and heaters on pages 40-41.





Premium

*Steady Flow - let your mind flow*





# Steady Flow

The latest addition to the Premium product category is the **Steady Flow tub**. **Steady Flow** is equipped with an efficient filter system and constant electric heating. The pleasant **Water Jets** water therapy nozzles in one of the walls, next to the seat, gently caress the back muscles and skin for that divine sense of relaxation. This hot tub, like all of Kirami's tubs, allows you to enjoy the natural surroundings without lights that change colour or loud disruptive sounds. Instead, the focus is on nature, filling your mind with peaceful satisfaction. **Could life be any more wonderful?**



**COMING**



Enjoy your hot tub year round





Summer is, naturally, the main season for hot tubs, but there is no reason why you could not enjoy them in the winter as well. For example, Christmas and New Year's Eve are great times to enjoy the warmth of a hot tub. There is no minimum temperature for their use.

Heating up a modern hot tub equipped with an external heater is no more difficult in the winter than it is in the summer. You need only fill the tub with water as usual, place logs and kindling inside the fire chamber and light the fire.

Depending on the ambient temperature, plan approximately half an hour to an hour of extra time for the heating in the winter. You should also factor in the initial water temperature if you are using water straight from an icy lake.

While heating the tub, keep it covered to prevent heat loss through convection. Stir the water occasionally to even out the temperature.

Place the hot tub close enough to your house or sauna to minimise the distance that bathers need to cover in the cold between the indoors and the tub. Using footwear suitable for wet conditions is recommended, and a bathrobe will provide some protection against the cold while you make your way to the tub. In addition to these, a beanie or a sauna hat should be worn while in the tub, as it will protect your head from the water vapours that will otherwise make your head cold.

Immediately after use, the hot tub should be drained to prevent parts that are susceptible to freezing from breaking, such as the heater or the drain pipe. However, please first check that no embers are left burning in the heater, as these will be hot enough to damage the insides of the heater when the hot tub is empty.

Once the tub has been drained, clean it as usual: wash the tub, empty the fire chamber from ashes and place the cover over the tub. The hot tub can now be left to wait for the next bathing session.





# Colours & Materials

The benefits of plastic tubs include great hygiene and flexibility. Dirt and impurities come off easily from the smooth inner surface, which does not peel even after years of use. The inner surface requires no maintenance, which means that the tub stays neat and clean year after year. Kirami's plastic tubs have been made out of either LDPE (low-density polyethylene) or HDPE (high-density polyethylene). LDPE and HDPE plastics are used in the food industry, and they are recyclable and UV protected. Both plastics come in several different colours. The inner surface of a tub made out of HDPE plastic is velvety smooth.

## Inside colours and materials:

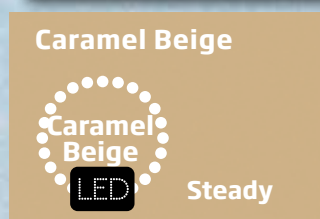
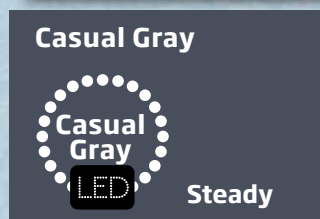
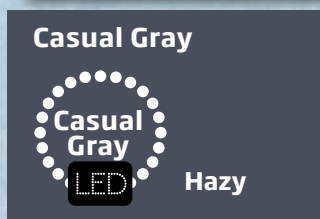
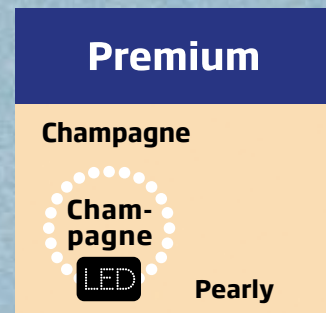
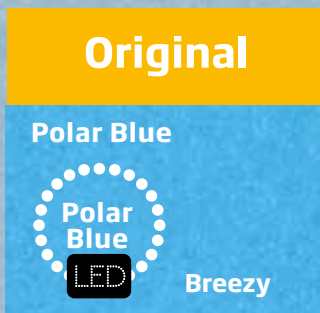

### Polar Blue

The fresh, translucent blue calms down and relaxes the mind after a busy day.

### Soft Beige

The translucent dotted beige is neutral, stylish and velvety smooth.

### Light Gray

The slightly translucent, velvety smooth dotted light grey is both trendy and timeless. Suitable for all environments.

### Ocean Blue

Velvety smooth, ocean blue dotted colour with a translucent surface.

### Casual Gray

The translucent grey is always stylish and aesthetic. Harmonious and suitable for many different kinds of environments

### Caramel Beige

The caramel-toned beige is a warm, translucent colour that highlights the peace of nature.

### Stone Gray

The soft, vivid grey blends in beautifully with the environment; it is always timelessly elegant.

### Champagne

A clear, magnificently glossy champagne colour for elegant and memorable bathing experiences.

The colours of the actual products may differ from the colours shown in the examples.



LED lights are available as an accessory for colours marked with this symbol.



Outside colours and materials:

**Original**

Stained Spruce (ST)

**Dark Walnut** Breezy Hazy

Stained Spruce (ST)

**Coal Black** Chill Breezy Hazy

Thermowood (TW)

**Thermowood** Tiny Woody Tiny Woody

**Comfort**

EcoPlank (EP)

**Night Black** Family M Family L Steady

EcoPlank (EP)

**Mocca** Family M Family L Steady

Stained Spruce (ST)

**Coal Black** Family M Family L

Red Cedar (RC)

**Red Cedar** Family M Family L Steady

Thermowood (TW)

**Thermowood** Family M Family L Steady

**Premium**

EcoStripe (ES)

**Night Black** Pearly

EcoStripe (ES)

**Mocca** Pearly

Red Cedar (RC)

**Red Cedar** Woody Tiny Premium Woody Premium Pearly

Metal (ME)

**Copper** Pearly

**EcoPlank (EP)**

A durable panel made out of recycled plastic with a smooth surface that requires no maintenance.

**EcoStripes (ES)**

A durable panel made out of recycled plastic with a grooved surface that requires no maintenance.

**Stained Spruce (ST)**

Natural stained spruce panel. The beautiful brown tint will stay goodlooking for a long time. We recommend re-staining every couple of years.

**Thermowood (TW)**

Original and natural heat treated pine panels have beautiful warm brown shade.

**Red Cedar (RC)**

Multi-hued, nearly branchless wood is very beautiful and becomes darker over time, into a more even grey hue. Top quality rot resistance.

**Metal, Copper (ME)**

The material requires no effort or maintenance and develops an elegant green patina over time.



# Heaters

All Kirami hot tub heaters are made in high-class AlMg3 marine aluminium, which is an excellent heat conductor. Every heater is pressure-tested for leakages before it leaves our factory.



|  | MICU                   | CULT                               | MACU                   | CUBE                                    | TUBE WOOD              | TUBE PLASTIC           |
|--|------------------------|------------------------------------|------------------------|---|------------------------|------------------------|
| <b>GROSS/NET OUTPUT KW</b>                         | 19 kW                  | 36/22 kW                           | 40/30 kW               | 48/35 kW                                | 60/42 kW               | 60/42 kW               |
| <b>HEATING TIME CHILL *</b>                        | 3 h                    | x                                  | x                      | x                                       | x                      | x                      |
| <b>HEATING TIME TINY/<br/>WOODY TINY *</b>         | 2 h                    | 1,5 h                              | x                      | x                                       | x                      | x                      |
| <b>HEATING TIME IN<br/>M SIZED TUBS *</b>          | x                      | 2,5-3 h                            | 2-2,5 h                | 1,5-2 h                                 | 1,5 h                  | 1,5 h                  |
| <b>HEATING TIME IN<br/>L SIZED TUBS*</b>           | x                      | x                                  | x                      | 2-3 h                                   | 2 h                    | 2 h                    |
| <b>FUEL</b>  | wood, charcoal         | wood, charcoal                     | wood, charcoal         | wood, charcoal                          | wood, charcoal         | wood, charcoal         |
| <b>CHIMNEY<br/>CONNECTION, MM</b>                  | 120                    | 120                                | 150                    | 150                                     | 150                    | 150                    |
| <b>WATER CAPACITY, L</b>                           | 22 l                   | 54 l                               | 79 l                   | 80 l                                    | 76 l                   | 76 l                   |
| <b>OUTSIDE<br/>MEASUREMENTS<br/>W X H X D MM</b>   | 340 x 400<br>x 565     | 340 x 580<br>x 678                 | 450 x 580<br>x 600     | 450 x 580<br>x 600                      | 727 x 700<br>x 687     | 693 x 700<br>x 687     |
| <b>FURNACE'S<br/>MEASUREMENTS<br/>W X H X D MM</b> | 279 x 338<br>x 494     | 279 x 186<br>x 569                 | 279 x 186<br>x 569     | 279 x 285<br>x 569                      | 348 x 248<br>x 569     | 348 x 248<br>x 569     |
| <b>STANDARD IN MODELS</b>                          | Tiny Wood<br>Chill     | Breezy<br>Tiny<br>Hazy<br>Family M | Steady<br>Family M     | Woody M<br>Steady<br>Family L<br>Pearly | Woody L<br>Woody XL    | Family L               |
| <b>OPERATING PRINCIPLE</b>                         | free circulation       | free circulation                   | free circulation       | free circulation                        | free circulation       | free circulation       |
| <b>ADJUSTABLE AIR VENT</b>                         | accessory              | accessory                          | accessory              | standard                                | standard               | standard               |
| <b>CONNECTION<br/>TO HOT TUB</b>                   | Ø 75 mm<br>smooth pipe | Ø 75 mm<br>smooth pipe             | Ø 75 mm<br>smooth pipe | Ø 75 mm<br>smooth pipe                  | Ø 75 mm<br>smooth pipe | Ø 75 mm<br>smooth pipe |
| <b>WEIGHT</b>                                      | 19 kg                  | 36 kg                              | 39 kg                  | 42 kg                                   | 50 kg                  | 50 kg                  |

Overall dimensions of the stoves are maximum dimensions including also mounting brackets and other protruding parts of the stove.

\*The heating durations presented here are estimates based on practical tests. The actual duration depends on the circumstances, the firewood's quality, size and humidity, the intensity of the maintained fire and the rate with which new firewood is added.



# Heating a hot tub

The external heaters, manufactured by Kirami, are high-quality and easy to use. Use spills to light dry firewood that has been chopped into small pieces. Keep the temperature hot to produce less visible smoke. The heating is at its most efficient when the tub is covered and the fire in the heater is as hot as possible. Ensure that there are no flammable materials in front of or under the fire chamber. The heater will not heat up above the water temperature as the stove is surrounded by a water jacket. Make sure that there is enough water in the tub.

## Hearth plate

The fireproof hearth plate designed for Kirami's heaters protects the area in front of the heater from sparks, improving the fire safety.

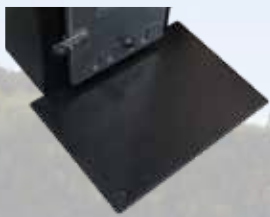

## Anode- Rod

Kirami's magnesium anode rod protects your heater from corrosion. The rod is screwed to the place reserved for it in the heater, and it is replaced approximately once per year.



## Chimney parts

Extension pieces and spare parts are also available for Kirami's heater chimneys. There are two types of the chimney sizes 120/150 mm.



## Heater glass doors

Available as an accessory, a glass heater door not only adds to the atmosphere of your hot tub by allowing you to enjoy the cozy glow of the fire, but also makes it easier to monitor wood consumption. The glass door is compatible with most Kirami hot tub heaters: **MICU**, **MACU**, **CULT** and new **CUBE** heaters (those manufactured after 2017).

# Tubtainer 2 - continuous heating and a filter

An easy-to-use electric heater for continuous heating and a filter unit for a hot tub. The system consists of an electric heater, a circulation pump, a filter and a control panel. The continuous heating will only consume electricity worth a few dozen cents a day, depending on the temperature outside. The water in the hot tub will remain ready for a swim up to several weeks, thanks to the integrated automated filter, if necessary cleaning agents are also used.

*Tubtainer 2 can keep the water in your hot tub heated in an easy and inexpensive way for up to several weeks.*

| TUBTAINER 2          |                                 |
|----------------------|---------------------------------|
| HEATING CAPACITY     | 2 kW                            |
| ENERGY SOURCE        | Electricity                     |
| DIMENSIONS W X H X D | 410 x 605 x 645 mm              |
| WEIGHT               | 33 kg                           |
| PURPOSE OF USE       | Continuous heating and a filter |





# Steps and drink holders

MADE IN +  
FINLAND

Thanks to their high-quality materials, the steps and drink holders we design and manufacture will last for years even in the harshest weather conditions. The sturdy steps guarantee that you can step safely into and out of the hot tub, and the drink holders increase the comfort and enjoyment of bathing. Some models also come in different colours and made out of different materials. You can find more detailed information at our website: [www.kirami.fi/en](http://www.kirami.fi/en)

**Step-A-round**



**Stepin**



**Chill**



**Family staircase**



**Delux**



**Drink Arc**



**Drink holder, 6 places for drinks**



**Drink Arc with legs**





# Kirami Tubbar 2

Tubbar 2 is a stylish floating drink holder designed by Kirami. Kirami's drink holders are of a high quality and user-friendly. They keep out the heat from the bath water, leaving your drinks nice and cold. They also serve as a delightful decorative element as they float from bather to bather. No one needs to get up to get the drinks, as they will always be within easy reach. Furthermore, the drink holders have symbols marking different spots to help everyone find their glass even though the holder is constantly moving around. The hole for a bottle in the middle is 11 cm in diameter, while the places around the edges for glasses are 7.5 cm in diameter. **The drink holder has been designed and manufactured in Finland.**





# Covers and locks



All of Kirami's hot tubs can be equipped with a cover. For most models, you can choose between a plastic or an insulated one, and dedicated versions exist for tubs with either an external or an internal heater. A cover is a highly useful thing to have: it makes heating your hot tub faster, keeps the water hot for longer and optimises heating performance when the tub is used multiple days in a row. It also stops foreign objects from getting into the water and keeps the hot tub clean while empty. Furthermore, it improves safety if you have children or pets, and protects the interior of your hot tub from UV radiation.

MADE IN +  
FINLAND





### **Round ABS plastic cover**

Fits a size M (170 cm diameter) hot tub with an external heater. The plastic cover becomes a safety cover when you add a safety lock to it, available as an accessory. A lockable hot tub cover is an important safety feature that prevents e.g. small children from getting into the tub unsupervised.

### **Safety lock**

A hot tub plastic cover can be equipped with a robust key-operated safety lock, available as an accessory.

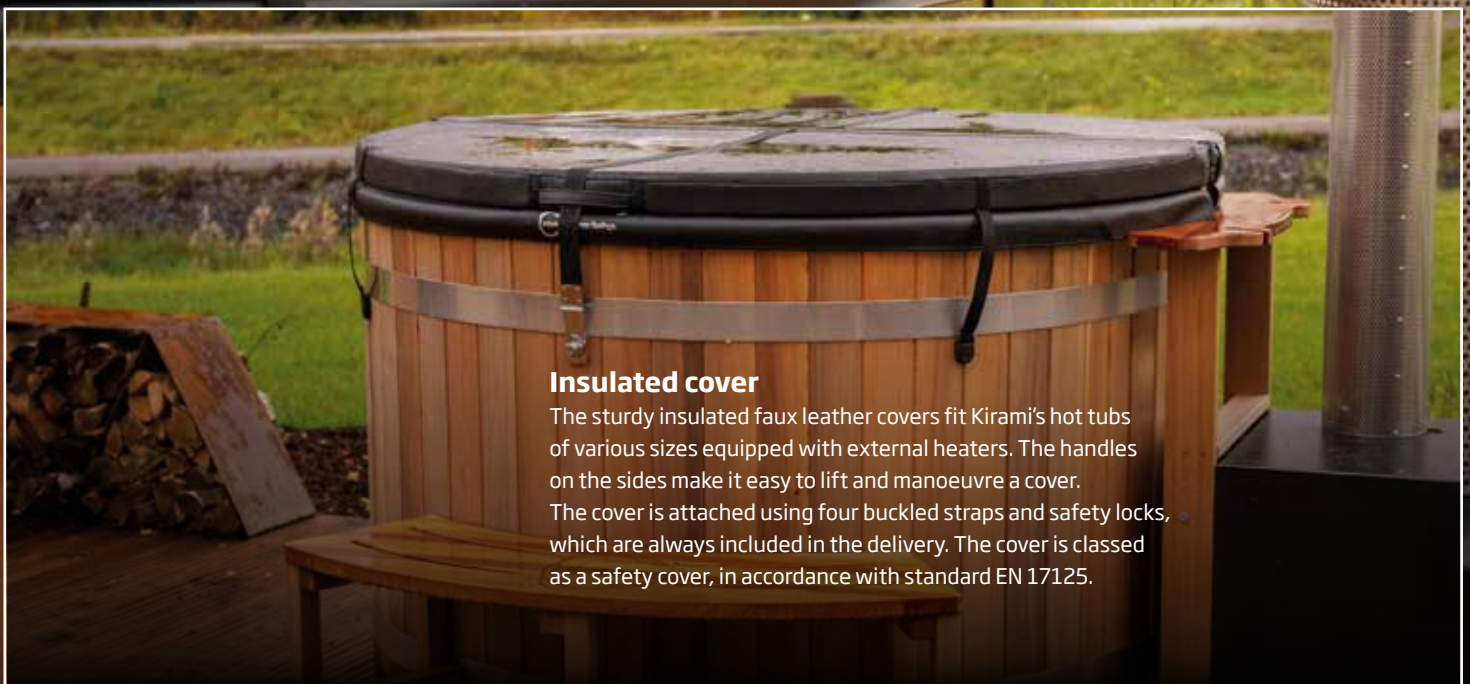

### **Insulated cover**

The sturdy insulated faux leather covers fit Kirami's hot tubs of various sizes equipped with external heaters. The handles on the sides make it easy to lift and manoeuvre a cover. The cover is attached using four buckled straps and safety locks, which are always included in the delivery. The cover is classed as a safety cover, in accordance with standard EN 17125.



# Carefully thought out accessories

Casual Gray

Polar Blue

Soft Beige

Champagne

Accessory

## LED lights

The LED lights that have been installed to the tub already at the factory create a magical atmosphere to bathing in the darkening night.



Accessory

## Extension pipe kit

The kit contains all the parts you need to install an outlet valve between the heater and the tub. The product does not include a Kirami outlet valve; it replaces the existing outlet.

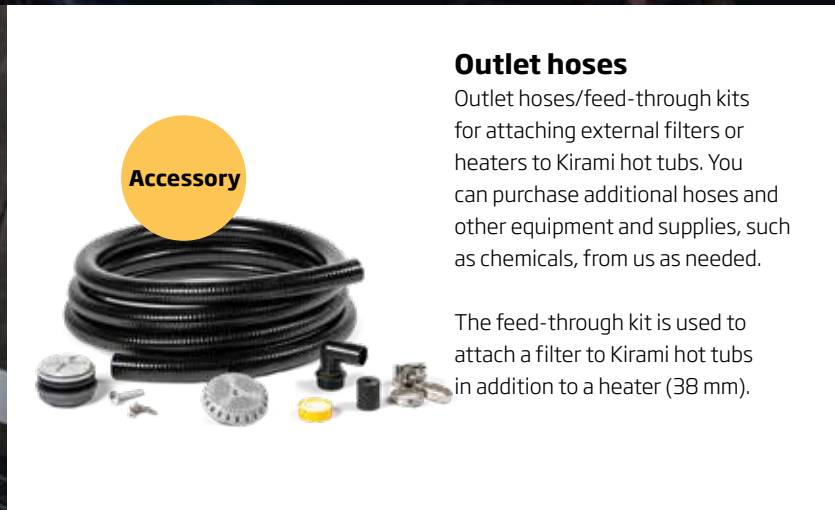

Accessory

## Outlet hoses

Outlet hoses/feed-through kits for attaching external filters or heaters to Kirami hot tubs. You can purchase additional hoses and other equipment and supplies, such as chemicals, from us as needed.

The feed-through kit is used to attach a filter to Kirami hot tubs in addition to a heater (38 mm).

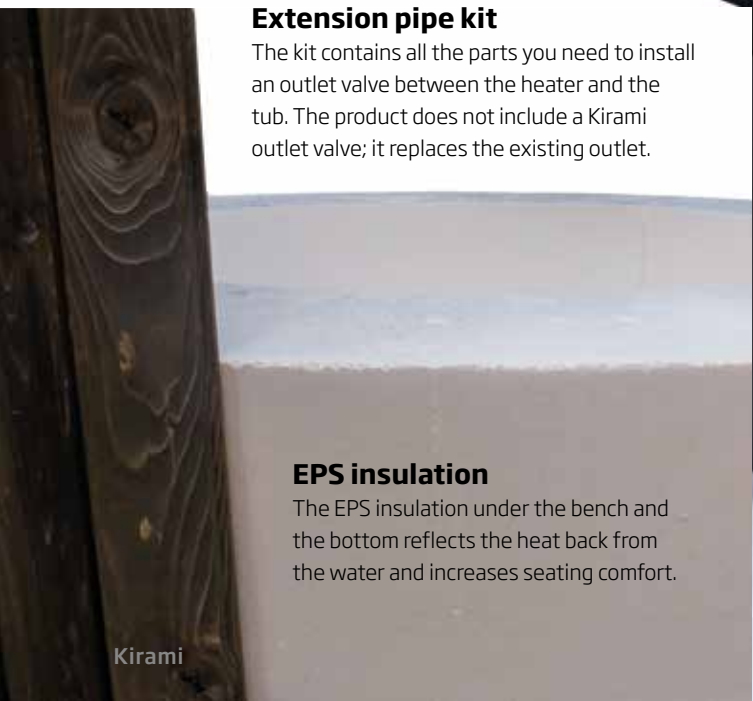

## EPS insulation

The EPS insulation under the bench and the bottom reflects the heat back from the water and increases seating comfort.



Accessory

## Side insulation

Hot tubs with plastic interiors can be equipped with additional insulation between the outer panels and plastic interior. The additional insulation consists of a 5 mm layer of insulating foam that is installed at our factory if the additional insulation is ordered with the hot tub.



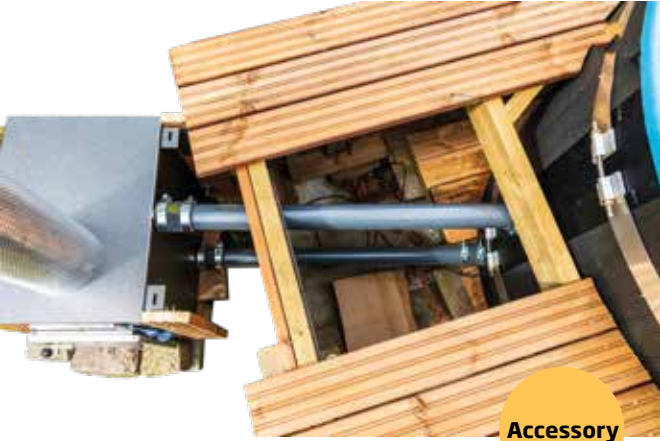

### Middle outlet kit

A middle outlet kit for Kirami's external heaters that makes it possible to connect the heater at a distance from the hot tub.

### Adjustment grids

Heater door adjustment grid for adjusting the air flow. The grid is standard equipment for the CUBE and TUBE heaters, and it can be purchased separately for the MICU, CULT and MACU heaters.



### Chimney parts

Extension pieces and spare parts are also available for Kirami's heater chimneys.  
200 cm (length), 150 mm (diameter)  
150 cm (length), 120 mm (diameter)

### Anode rod

Kirami's magnesium anode rod protects your heater from corrosion. The rod is screwed to the place reserved for it in the heater, and it is replaced approximately once per year.



### Hearth plate

The fireproof hearth plate designed for Kirami's heaters protects the area in front of the heater from sparks, improving the fire safety.



### Heater glass doors

Available as an accessory, a glass heater door not only adds to the atmosphere of your hot tub by allowing you to enjoy the cozy glow of the fire, but also makes it easier to monitor wood consumption. The glass door is compatible with most Kirami hot tub heaters: **MICU**, **MACU**, **CULT** and new **CUBE** heaters (those manufactured after 2017).





# Easy water hygiene with Kirami

## How to keep your bathwater clean

You do not need to change the bathwater in the hot tub after every use, but if you reuse the same water, special attention must be paid to water hygiene.

## Keeping water clean consists of two aspects:

- Maintaining the physical cleanliness of water with a filter.
- Eliminating bacteria and microbes with water treatment agents.

## Filtering

The filter is intended to clean the water from dust, leaves, the dirt caused by bathing, and other impurities. This is done by circulating the water in the tub through a filter. There are different types of filters, such as light filters suitable for smaller pools that use a filter cartridge, as well as more efficient filters that use either filter sand or filter fibre.

## Chemical cleaning

The hot tub water can be cleaned chemically either with chlorine or active oxygen. The correct water pH value is maintained with pH- and pH+ granules. In addition, there are chemicals available for preventing algae growth and clarifying water.

## Other cleaning

It is important to keep the hot tub clean even when it is not in use. Warm water and sunshine easily cause algae growth in the bottom and walls of the tub. The algacide prevents algae bloom, and its use is recommended especially on hot summer days. Small dirt particles may bypass the filter system, making the water in the tub look discoloured or cloudy. The small impurities in the water can be precipitated with a clarifying agent, which makes it easier to filter them out of the tub.



WATER HYGIENE



*MF 250, a high quality filter is suitable for Kirami hot tubs and filters away dust, leaves, other dirt and impurities that come from bathing.*





# BIOCOOL

MADE IN SWEDEN



**BioCool offers simple, gentle and effective products for keeping the water clean that are safe for both people and the environment. BioCool participates in the fight to reduce the use of chlorine and antibiotics.**

## BioCool Disinfect my pool

**Easy-to-use and effective liquid pool water disinfectant.**

- Odourless and biodegradable.
- Completely chlorine-free, meaning that it does not include chlorine compounds that are harmful to health.
- Works with different pH values without losing effectiveness.
- Easy to dose directly from the bottle with the dosing module.
- Replaces chlorine, shock chlorination and algaecides and eliminates the need for pH measurement and adjustment.



## BioCool Clear my pool water

**BioCool Clear my pool water flocculating agent.**

- Helps remove small particles that make the water in the pool or tub cloudy.
- Causes particles that are too small for the filter to aggregate so that they can be captured by the filter.



## BioCool Clean my pool filter

**Swimming pool filter cleaning agent.**

- BioCool Clean my pool filter cleans the filter cartridge by dissolving dirt, without the need for scrubbing.
- Removes dirt and harmful microorganisms, such as bacteria, parasites and fungi.
- Cleaning the filter cartridge regularly guarantees the hot tub water quality.



## BioCool Shock my spa system

**All-round cleaner for the pool, both for the hose and pipe system.**

- Recommended to use 3-5 times a year before changing the water.
- Reduces the formation of biofilm and layers, which improves the bath water quality.
- One 1000 g jar is enough for a 1000 litre water system.
- Environmentally friendly, chlorine-free and easily degraded in the nature.



**Use biocides safely. Always read the labels and product information before use.**

**None of the BioCool water treatment products contain chlorine compounds that release active chlorine, which means that they do not produce chloramines that are harmful to health.**



# For longer water life, invest in a filter

When ensuring the water in the hot tub is clean there are two cornerstones: the water treatment chemicals, and a proper filter. The filter will remove all the physical impurities from the water. By using these two forms of cleaning together, you don't have to change the water so often. After the use, it is essential to make sure that also the tub itself is clean. For that purpose, Kirami has its own high-quality detergents.

## FILTERS



### Mass filter MF250

MF250 is a small and efficient mass filter. As a filtering medium, you can use either traditional filtering sand or Kirami filter fibers, both of which can be washed and rinsed. You can also easily replace the medium when necessary.



### CF23 Cartridge filter

An effective external cartridge filter that works well with Kirami hot tubs. The cartridge can be washed and rinsed with running water or replaced, if necessary.



### Tubtainer 2 heater and filter combo

Easy-to-use, electric heater and filter combo for hot tubs. The water in the tub stays usable for a long period of time with the integrated filter when you use the needed chemicals in the tub.

## POOL AND HEATER DETERGENTS



### Biowash, concentrate 5 litres

Biodegradable washing agent for cleaning and degreasing outdoor hot tubs and saunas.



### Biowash, spray 0,5 litres

Pre-diluted, biodegradable washing agent for cleaning and degreasing outdoor hot tubs and saunas.



### Sootwash, spray 0,5 litres

For removing soot and stubborn dirt from outdoor hot tub stoves, fireplaces and fireboxes.



# Tub care

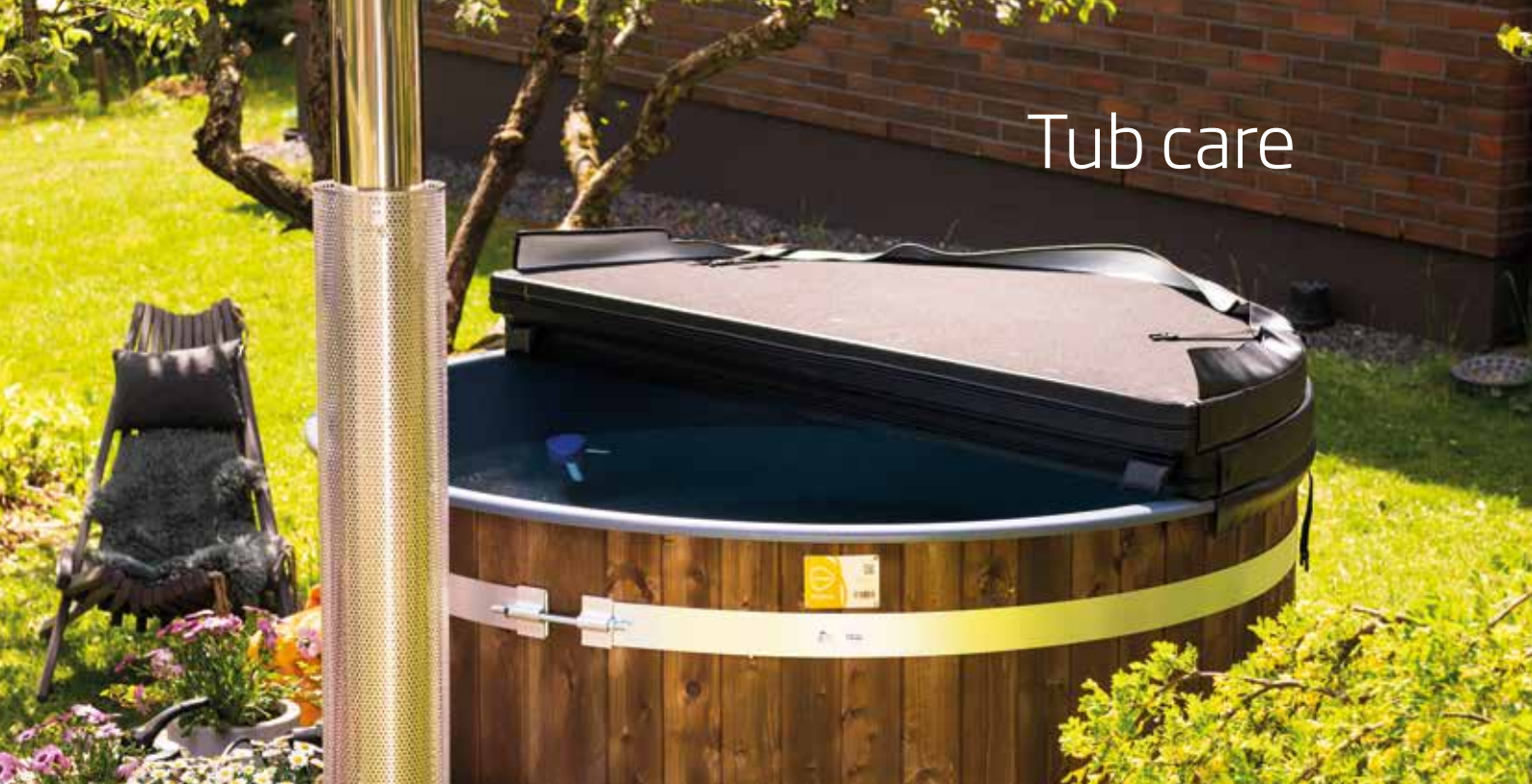

**Q: What is the service life of the hot tub?**

**A:** The service life of plastic tubs is more than 15 years, but the wooden parts (panels) age/wear over time. The service life of wooden tubs is approximately 5-10 years, depending on how well it is maintained (washing, oiling and good ventilation).

**Q: Are plastic hot tubs easier to keep clean than wooden models?**

**A:** Plastic tubs are easier to clean, as dirt and impurities come off more easily from their smooth inner surfaces.

**Q: How should I maintain the inner surface of the hot tub?**

**A:** We recommend regularly washing the inner surface with detergent (such as Kirami Biowash), rinsing it with water and drying it thoroughly. The inner surface of a wooden tub requires more thorough cleaning than plastic tubs. However, take care not to scrub the inner surfaces too vigorously in order to avoid scratches.

**Q: Can I treat the inner surface of a wooden hot tub with oil?**

**A:** We do not recommend treating the inner surface of a wooden tub with oil or other similar substances, as they dissolve into the bathwater when the water is heated. The outer panels can be treated with various wood oils or stains, both water- and solvent-dilutable. In other words, you can use almost any wood treating products sold at hardware stores.

**Q: How should I maintain the outer surface of the hot tub?**

**A:** Stained, ThermoWood and spruce surfaces can be treated with wood oil, provided that they do not form a layer that could damage the panels as the wood swells and shrinks. For ThermoWood and stained spruce panels, you can use wood oil that can be diluted with water in a suitable shade of brown. Composite panels only need to be washed every once in a while. Red cedar panels can be treated with paraffin oil. When treating the tub panels, you can remove the outer hoops or cover them with adhesive tape during treatment, immediately removing any splashes or runoffs.

**Q: Why is plastic a good material choice for the hot tub?**

**A:** Plastic is a homogeneous and wear-resistant material. Plastic has a dirt-repellent surface, enabling quick and easy cleaning. You can also clean it with a pressure washer. Plastic requires no maintenance, withstands time, is UV-protected and can be used in any weather. It is environmentally friendly and recyclable.

**Q: How often should I change the bathwater?**

**A:** We recommend changing the bathwater after one or two days in normal family use. With correct filter and chemical use, the water can stay usable for bathing for 1-3 months. You should always use a sanitising chemical if you bathe in the water more than once.



# Kirami is also a safety pioneer

Kirami was the only Finnish hot tub manufacturer to be actively involved in creating the new EU standard EN 17125 for the safety requirements and test methods related to domestic hot tubs. The safety of small children is especially important to Kirami, and the topic has also played a central role in the work done on the standard.

Companies in the field as well as safety authorities, such as the Finnish Safety and Chemicals Agency (Tukes) and other European agencies, have been involved in the development. The standard takes safety perspectives, technical details, quality and different kinds of instructions into account. When customers buy a hot tub compliant with this standard, they can be sure that the product is safe.

## This is how we meet the requirements of the standard

### Cover

The standard pays special attention to the safety of children. A hot tub cover is the most effective way to ensure that children cannot enter the tub without supervision. Adults are always responsible for the safety of children in the end, and they must monitor the children in the vicinity of the tub and ensure that the cover is locked while the tub is unsupervised.

All of Kirami's hot tub models have a suitable high-quality cover available that is easy to handle and can be equipped with a safety lock. In addition to safety, the cover has other benefits.

- Prevents children from entering the tub without supervision.
- Protects the tub from debris and UV radiation.
- Heats the water faster.
- Keeps the water warm for longer.
- Reduces the need to heat the water on the following day.



### Steps

The standard requires that the user has a safe route into and out of the hot tub.

Usually this requires steps on the outside; the end customers can naturally choose whether to add steps or not. Kirami offers a variety of steps for all available hot tubs.

- You can climb safely into and out of the tub.



### Grates

One of the standard's most important safety requirements is that there must not be any holes inside the tub in which hands, fingers, feet, toes or a head could get stuck under water. In Kirami's tubs, such holes are covered with protective grates.

- Increase safety by preventing fingers and toes from getting stuck.
- Reduce the amount of rubbish that ends up in the water circulation.

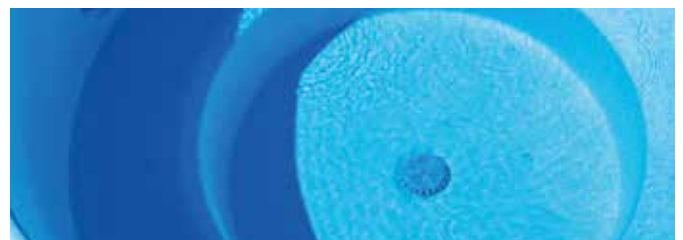

### Thermometer and mixing paddle

The standard requires monitoring the hot tub water temperature in order to ensure that the temperature is safe for bathing. This can be done with different types of thermometers.

Before measuring the temperature, the hot surface water needs to be mixed with the cooler water below to ensure that the measurement results are accurate. This can be done easily with Kirami's mixing paddle, for example. You should still check the water temperature with your own elbow before stepping into the hot tub!



- Mix the water to ensure an even temperature
- The thermometer shows you when the water temperature is suitable.

### Heat shield, chimney cap and fireproof plate

The standard also aims to ensure the fire safety of hot tubs and heaters.

The heat shield, chimney cap and fireproof plate promote fire safety. Naturally, Kirami provides all necessary instructions on the minimum distances related to fire safety in accordance with the standard. When heating is done according to the instructions, i.e. the tub is filled with water before starting the heating, the outer surface of Kirami's heaters will not get hot enough to burn. Thanks to the free water circulation, the aluminium heater is cooled by water.

- The heat shield protects you from the hot chimney pipe.
- The chimney cap reduces the number of sparks spreading into the surrounding nature.
- The fireproof plate prevents embers from falling into easily flammable ground.



Minimum distances between hot tubs heated with wood and flammable objects

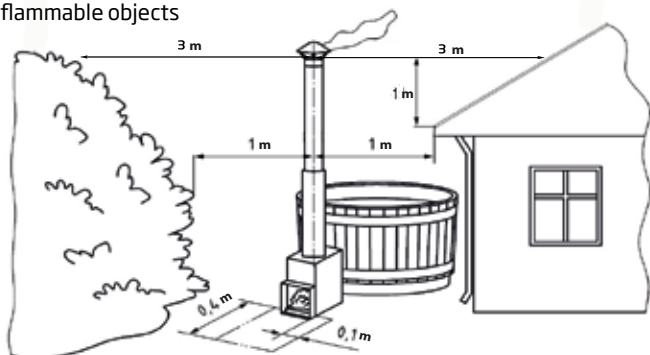

### Water hygiene

The standard requires that appropriate instructions for keeping the water clean must be available and the user must be able to follow them easily. In addition to instructions, Kirami offers a whole range of water treatment products. Ask your retailer for more information.



### Durable, traceable and recyclable materials

The standard also makes statements on the manufacturing materials and the overall product quality.

The Kirami hot tubs and the Outstanding products are made to last, and all hot tubs have a two-year warranty. All materials in a tub can be recycled. The tub heater and the hoops go to metal recycling. The wood, rubber and plastic parts can be recycled to be reused or used as energy-from-waste. Sorting the materials at the waste collection will be easier if you have disassembled the tub yourself. When you separate the materials carefully, you will make waste collection easier and reduce the waste fee you need to pay.

- The warranty works reliably.
- You can still get spare parts and equipment for your hot tub years later.
- You can replace your Kirami hot tub without needing to worry about anything.





# Safe bathing

Below, you can see explanations of the symbols related to operating safety shown in connection with the hot tub.



Before starting heating, fill the hot tub with water up to the minimum level, i.e. approximately 5 cm above the upper pipe of the heater.

- Read the instruction manual and safety regulations before use.
- Keep an eye on the children while they are in the hot tub.
- Jumping into the hot tub is prohibited!
- Do not push your fingers through any of the hot tub openings.
- Be careful of the hot surfaces!



Kirami's partners, the actor Ville Haapasalo and the inventor Janne Käpylehto



# Kirami FinVision -saunas



Kirami FinVision -saunas honour ancient Finnish traditions. They include all those elements that make bathing in a sauna such a relaxing and magical experience, but that is not all. Their cosy interiors immerse bathers into a pleasant atmosphere and the large panoramic window brings the surrounding nature closer. As the name implies, the Kirami FinVision -sauna offers a fresh new angle to an old tradition.

Designed by fine carpenter Mika Pitkänen, these saunas represent top-level craftsmanship. The building itself comes as a pre-fab module, and all the wiring has been completed as 'plug and play'. The functional details include the pre-installed atmospheric LED lights and benches that can be lifted up for easy cleaning.

All of Kirami FinVision -saunas are insulated, making them energy-efficient and suitable for colder climates as well. The insulation helps the saunas heat up faster and retain the heat for longer.



# Kirami FinVision -sauna Original

A photograph of a modern outdoor sauna. The sauna is constructed from dark grey wood and features a large, floor-to-ceiling window and a matching glass door on the right side. A black chimney pipe extends from the roof. The sauna is situated on a wooden deck. In the foreground, there is a fire pit on the left, a wicker basket with autumn plants, and a lantern on the right. The background shows a forest with trees in autumn foliage under a cloudy sky.

A large window made from smoke-grey, tempered, selective glass adds a sense of space and lightness to the sauna. It also improves the building's energy efficiency. A grey glass door matches the window and is equipped with a magnetic lock that ensures smooth opening and closing and secures the door. The door is right-handed and located on the right side of the sauna by default. However, it can be made left-handed and placed on the left side of the sauna. Please make any custom requests when placing an order.



**M**

4-6

The spacious but compact Kirami FinVision -sauna Original is 5.3 m<sup>2</sup> in size and around 2.6 m tall. It is intended for 4-6 people. The internal and external walls are made from treated Finnish conifers. The staggered, plain-sawn exterior planks give the sauna a lively look, while the dark interior walls create a subdued setting for easy relaxation. The light grey benches provide an elegant contrast to the otherwise dark interior surfaces, and the LED lighting underneath the benches sets the mood. The benches can also be lifted up for cleaning and maintenance. You can purchase a Kirami FinVision -sauna with an electric, wood-burning or steamer heater, or without a heater.



A changing room can be added to the sauna and equipped with a bench, LED lighting and a clothes hanger.

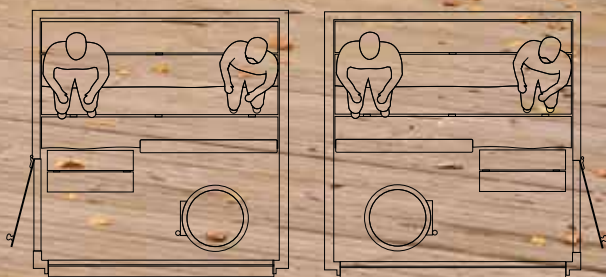

On request, a sauna may also be built in mirror image.



|                                  | <b>ORIGINAL</b>  |
|----------------------------------|--|
| <b>LENGTH</b>                    | 2300 mm  |
| <b>WIDTH</b>                     | 2300 mm  |
| <b>HEIGHT</b>                    | Transport height 2580 mm, finished height 2625 mm                            |
| <b>VOLUME</b>                    | Interior: 8,9 m <sup>3</sup> / Exterior 13,5 m <sup>3</sup>                  |
| <b>SAUNA HEATER</b>              | Harvia Legend 240 / Harvia Cilindro XE 9kW / Harvia Virta Combi HL110S 11 kW |
| <b>OUTER SURFACE MATERIAL</b>    | Spruce plywood and plain sawn spruce   |
| <b>INTERIOR SURFACE MATERIAL</b> | Spruce plywood and plain sawn spruce   |
| <b>NUMBER OF PEOPLE</b>          | 4-6  |
| <b>CONTENTS OF THE DELIVERY</b>  | Delivered assembled, excluding the roof, which must be installed on site     |



# Kirami FinVision -sauna Nordic misty



**Kirami FinVision -sauna Nordic misty is available with a stylish black Harvia Virta Combi steamer heater, complete with a cup and a grate for sauna fragrances. The heater can also be used like a normal electric sauna heater without the steam. In addition to this, an infrared element will become available soon as an accessory. The sauna's LED lights are connected to the heater's Xenio Combi CX110C control panel. A changing room can be added to the sauna and equipped with a bench, LED lighting and a clothes hanger. The Nordic misty saunas are always insulated and delivered fully assembled.**



**M**

4-6

The surface-treated Kirami FinVision -sauna Nordic misty is made from timeless black spruce panels and heat-treated aspen. The clear-cut and simple style suits a variety of gardens. The sauna has 5.2 m<sup>2</sup> of floor space, is 2.55 m tall and has room for 4-6 people. The finishing touches on the benches and other interior surfaces make them stunningly beautiful. The dark colour and scent of aspen create a pleasant and inviting atmosphere, which is further complemented by LED lighting underneath the lower bench and at the top of the backrest. The large glass surfaces bring you close to nature. The double-glazed window made from grey, tempered, selective glass also improves the sauna's energy efficiency, and the argon gas between the panes acts as an insulator. The outside surface of the window is reflective.

Deep  
BlackTW  
Aspen

All the wiring has been completed as 'plug and play'.



On request, a sauna may also be built in mirror image.

|                                  | NORDIC MISTY  |
|----------------------------------|---|
| <b>LENGTH</b>                    | 2300 mm   |
| <b>WIDTH</b>                     | 2250 mm   |
| <b>HEIGHT</b>                    | 2550 mm   |
| <b>VOLUME</b>                    | Interior: 8,1 m <sup>3</sup> / Exterior:12,9 m <sup>3</sup> |
| <b>SAUNA HEATER</b>              | Harvia Virta Combi HL110S 11 kW                             |
| <b>OUTER SURFACE MATERIAL</b>    | Black spruce panel  |
| <b>INTERIOR SURFACE MATERIAL</b> | Heat treated aspen  |
| <b>NUMBER OF PEOPLE</b>          | 4-6   |
| <b>CONTENTS OF THE DELIVERY</b>  | Delivered assembled   |





**Kirami FinVision -sauna offers pleasures for all senses, but it is also easy to use and care for.**

**The benches can be lifted up, which makes it easy and effortless to clean the sauna and keep it tidy.**

**Harvia's high-quality heaters ensure the best heat distribution. The options include electric and wood-burning heaters, both of which are top-class in their design and exceptionally impressive in appearance.**

**The Harvia Virta Combi steamer heater provides pleasantly soft and humid heat. The multi-function Xenio Combi CX110C control panel displays all the relevant information and can be used to control the heater as well as LED lights in the sauna.**

**The sauna's surface materials are easy on the eye, reflecting the Finnish nature.**

## Kirami FinVision – beauty and practicality



**Deep Black**

**Rustic Grey**

**Deep Grey**

**Aspen**





Harvia Cilindro XE 9kW



Harvia Legend 240



Harvia Virta Combi



Xenio Combi CX110C control panel



# Caring for your Sauna



**Q: What should I take into account when cleaning the sauna on the inside?**

A: Make sure the sauna stays clean and hygienic by washing it sufficiently often. Generally, we recommend that users wash themselves before entering. Bench towels protect the seats and keep the sauna more hygienic. However, you should also wash your sauna regularly.

Before washing, clear away any ashes from a wood-burning heater and sweep the floors. We recommend using environmentally friendly cleaning agents, such as Kirami's Biowash, for washing the sauna. Rinse the walls, benches and floor well after washing. Check once more that the air gap under the sauna benches is clear from debris to ensure good air circulation during use.



**Q: How often should I replace the stones in my heater?**

A: The stones should be replaced regularly to ensure that the heater is able to operate appropriately. There is no need to do this every year, but you should take the stones out of the heater and rearrange them.

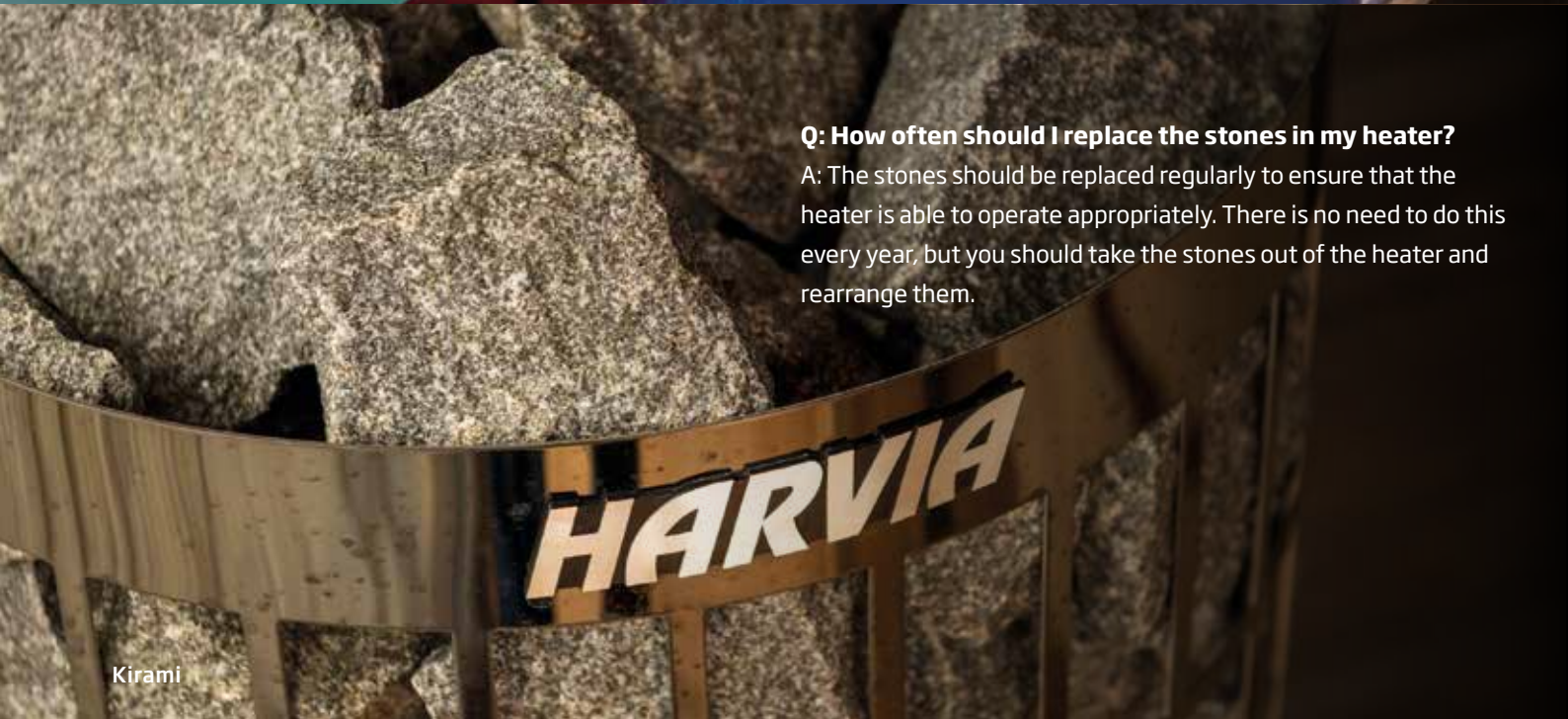





**Q: Do I need to do something to the benches and interior surfaces of a sauna?**

A: The benches and walls have been treated to withstand high humidity. You can re-treat them by applying a suitable, commercially produced wood oil. You can order the original wood oil from a reseller, but wood oils intended to be used in saunas can also be found in hardware stores.



**Q: How should I care for the external walls of a sauna?**

A: As the external surface of your sauna is made from natural materials, which will become lighter in colour over time, depending on the amount of sun, you can treat the walls with a suitable product, if necessary. The walls have been treated with water-soluble wood oil at the factory, and you can either purchase some from a reseller or use a wood oil intended for outdoor use available from a hardware store. If you want to keep the original colour, a coat of wood stain must be applied to the outside walls every few years.



# Kirami FinVision Experience.

Our love for saunas and bathing led us to create our own high-quality product family of top-grade textiles and accessories, and we decided to call it Kirami FinVision Experience.

We feel that Kirami FinVision Experience reflects the essence of what Kirami products are about: sensations, pleasure and experiences. Life is here and now, and we must be able to enjoy it.



## BATHROBES

Our timelessly elegant bathrobe has a wide hood and handy side pockets. The bathrobes are 100% cotton, durable when used and washed, and they do not cause an itch or irritate the skin. The same design suits both men and women.

Kirami

## TOWELS

Our attractive and wonderfully soft towels are made from 100% cotton honeycomb fabric and allow you to dry yourself off gently after enjoying a sauna or a hot tub. A true everyday luxury.





#### TUB HATS

A tub hat will keep you warm in the winter and deter insects in the summer, and it will add a bit of humour to your bathing sessions, regardless of the season. In the sauna, a tub hat will protect your hair and scalp from the heat.



#### WASHBAG

Our washbags are handmade in Finland in collaboration with Purye Clothing using recycled sailcloth and leftover leather. The bag helps you organise all your sauna essentials and have them at hand at all times.



#### BENCH TOWEL

Our high-quality bench towel feels pleasant against your skin. The size of the towel is 45 x 55 cm, and it is made from 100% cotton. The towel will maintain its shape and colour despite repeated washing.





# Outstanding

by KIRAMI

When guys get together. When form meets plain steel.  
When the passionate barbecuer gets together with  
the live flames. When the splashes of the soul meet  
the warmth of the tub. "Look, your evening is ready."

MADE IN  
FINLAND





# IRON MONSTER

Iron Monster is a frying plate made from sturdy rolled steel. It can handle juicy steaks for a whole group of people in one go. This extremely versatile cooking implement works like an old-style stove.

Iron Monster needs to be placed over a firepit. The best option is a Roasty Boss pot, which now comes with an updated stainless steel base. Together, they form an Iron Monster BBQ.

The stone basket that acts as the base can be filled with stones that match the surroundings or left empty. All these components can also be bought separately.



**Iron Monster BBQ**

*Diameter 762 mm*

*Height 625 mm*



**Roasty Boss Pot**

# ROASTY BOSS

Roasty Boss is a heavy-duty BBQ grill, guaranteed to fill the needs of even the most demanding of cooks. A wide range of accessories from cooking and frying plates to grates. Roasty Boss is the summer cook's right hand, cooking steaks simultaneously for even a larger company while a pot of potatoes boils on the side. The frame is made of weathering Corten steel, and the rest is stainless steel. The Roasty Boss is the dream for BBQ chefs who are passionate about cooking. The equipment is sturdy and durable in use, and there is plenty of space to make several dishes at the same time.



**Roasty Boss**





## TRIHOLDY

Triholdy is a new, highly adaptable, outdoor decor sensation. The triangular elements can be combined to build an individual storage unit, partitions and firewood holders for the patio. Build a privacy screen or windbreak for the hot tub to match the style of your garden. The Triholdy can be transformed into a green wall using different arrangements of potted plants. Or the triangles can be laid flat and used as a planter.





# LEATHER PATRON

This is no beer barrel cover - this is a truly stylish and manly apron, made out of thick antiqued leather of high quality, of course. A leather apron distinguishes the uncrowned king of the grill, and it makes an excellent gift.



# KINDLING CRACKER

A safe and easy-to-use way to split firewood into kindling. Kindling Cracker is durable, because it is made out of one single piece of cast iron, and brushing is normally the only maintenance it needs.

Cooking over open flames and eating outdoors stimulate all of our senses. Top chef Jesse Söderlund's cookbook, LET'S EAT OUT, is a collection of best recipes for outdoor eating.



**TIP:**

Get the best results in all grilling with Outstanding charcoal or birch firewood!

Watch LET'S EAT OUT recipe videos here!





## KIRAMI'S PARTNERS



### Valepa

VaLePa is one of the most successful Finnish volleyball teams of all times, and it has won four out of five Finnish championships in recent years as well as several Finnish Cups, the latest one in 2020.

### Rauman Lukko

Founded in 1936, Rauman Lukko is a Finnish ice hockey team and a two-time winner of the Finnish Elite League, in 1963 and 2021. The club has also won several bronze and silver medals over the years.

### Katri Lyynerä

A young and talented cross-country skier from Vammala, Finland. She took part in six Nordic Junior World Ski Championships, and since 2017 she has competed at adult events, such as the Nordic World Ski Championships 2017 in Lahti.



## *You deserve luxury in your life!*

You can recognise Kirami's products from their careful thought-out finishing touches. Kirami manufactures its hot tubs and saunas by using durable high-quality materials that offer various options for varying tastes. The products are practical and easy to care for, which contributes to their quality, and you can start using them without any excess fuss. We want to provide our customers with memorable and enjoyable bathing and sauna experiences, regardless of the season.

***Our strength comes from customer satisfaction!***



Good to know

---

# Ordering Kirami products

Ordering Kirami has more than 20 resellers all over Europe. You can find your nearest reseller on our website: [www.kirami.fi](http://www.kirami.fi).

The resellers will give you an offer for the products you choose. Time and way of delivery depend on the product you wish to have.

The delivery of the tub can be arranged for the requested address.

## Product registration

Remember to register the Kirami product you have purchased on our website. Registration offers you several great benefits. If you wish, you can get tips for using your products and offers related to them. In addition, we will also send a small gift to everyone who registers a Kirami product.

## User manuals

Each hot tub and heater includes a user manual. You can also download the latest user manuals from our website.

**[www.kirami.fi](http://www.kirami.fi)**

All rights reserved





[www.facebook.com/kirami oy](https://www.facebook.com/kirami oy)



[www.instagram.com/kirami oy](https://www.instagram.com/kirami oy)



[Kirami Oy Youtube channel](https://www.youtube.com/channel/Kirami Oy)

[www.kirami.fi/en/blog](https://www.kirami.fi/en/blog)



*Warmer feelings.*

**Kirami Oy**

Villiläntie 2, 32730 Sastamala

Finland

[info@kirami.fi](mailto:info@kirami.fi)

[www.kirami.fi](https://www.kirami.fi)

01/2022/1000